



Nothing but **HEAVY DUTY.**

# ULTIMATE PRODUCTIVITY. SUPERIOR PERFORMANCE.



**HAND TOOLS | STORAGE | SAFETY  
SPRING 2020**

## STUD™ TAPE MEASURES

### INDUSTRY'S MOST DURABLE TAPE MEASURE

**17' REACH\***



**SURVIVES 80' DROP\*\***

Fully Reinforced, Impact Resistant Frame

Longest Lasting Blade



**RIP & WEAR RESISTANT BLADE TECHNOLOGY**

**Finger Stop**  
Protects from blade retraction

**2-Sided Printing**  
Increased measurement readability

**Anti-Tear Coating**  
Reinforces first 6" of blade



Rip & Wear Resistant Blade

Model #	Description
48-22-9716	16ft STUD™ Tape Measure with 16' Reach*
48-22-9725	25ft STUD™ Tape Measure with 17' Reach*
48-22-9735	35ft STUD™ Tape Measure with 17' Reach*

Model #	Description
48-22-9717	5m/16ft STUD™ Tape Measure with 16' Reach*
48-22-9726	8m/26ft STUD™ Tape Measure with 17' Reach*
48-22-9725M	25ft STUD™ Magnetic Tape Measure with 17' Reach*

## WIDE BLADE TAPE MEASURES

### LONGEST REACH STRAIGHTEST STANDOUT†

**17' REACH\***

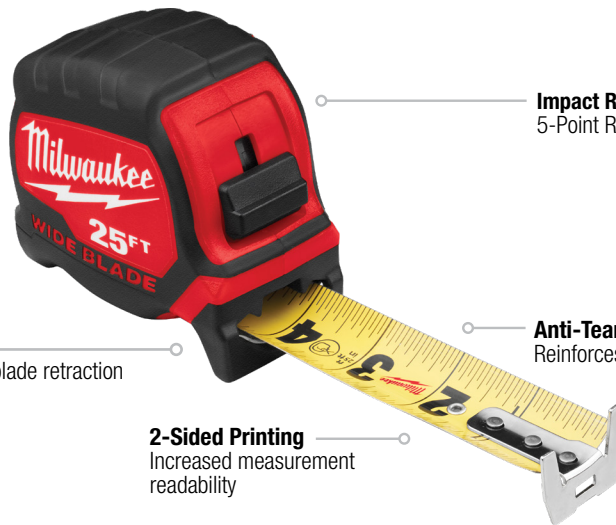

**Impact Resistant Frame**  
5-Point Reinforced

**Anti-Tear Coating**  
Reinforces first 6" of blade

**Finger Stop**  
Protects from blade retraction

**2-Sided Printing**  
Increased measurement readability



Long Reach for Efficient Measuring

Model #	Description
48-22-0216	16ft Wide Blade Tape Measure with 16' Reach*
48-22-0225	25ft Wide Blade Tape Measure with 17' Reach*
48-22-0230	30ft Wide Blade Tape Measure with 17' Reach*
48-22-0235	35ft Wide Blade Tape Measure with 17' Reach*
48-22-0240	40ft Wide Blade Tape Measure with 17' Reach*

Model #	Description
48-22-0217	5m/16ft Wide Blade Tape Measure with 16' Reach*
48-22-0226	8m/26ft Wide Blade Tape Measure with 17' Reach*
48-22-0216M	16ft Wide Blade Magnetic Tape Measure with 16' Reach*
48-22-0225M	25ft Wide Blade Magnetic Tape Measure with 17' Reach*



## COMPACT WIDE BLADE TAPE MEASURES

**15' REACH\***

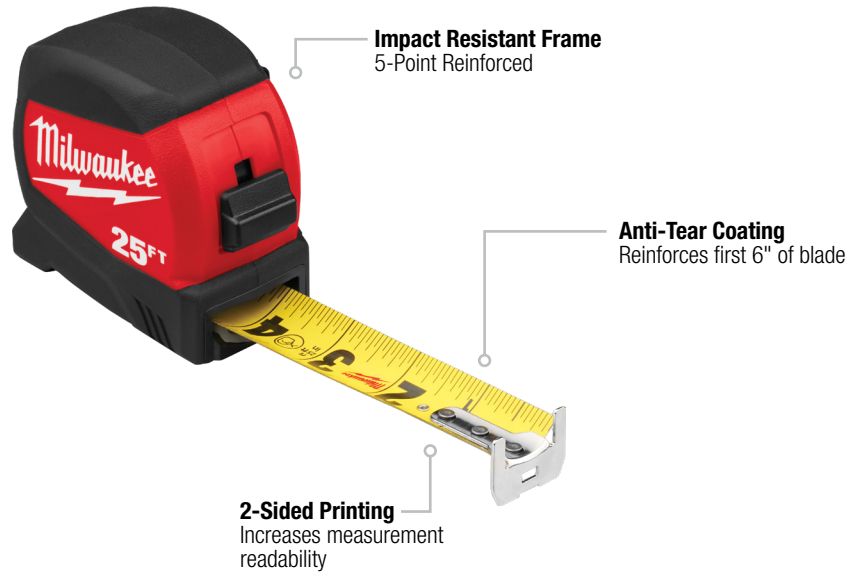

2-Sided Printing

Model #	Description
48-22-0416	16ft Compact Wide Blade Tape Measure with 15' Reach*
48-22-0425	25ft Compact Wide Blade Tape Measure with 15' Reach*
48-22-0430	30ft Compact Wide Blade Tape Measure with 15' Reach*
48-22-0417	5m/16ft Compact Wide Blade Tape Measure with 15' Reach*
48-22-0426	8m/26ft Compact Wide Blade Tape Measure with 15' Reach*
48-22-0316	16ft Compact Wide Blade Magnetic Tape Measure with 15' Reach*

Model #	Description
48-22-0325	25ft Compact Wide Blade Magnetic Tape Measure with 15' Reach*
48-22-0335	35ft Compact Wide Blade Magnetic Tape Measure with 15' Reach*
48-22-0317	5m/16ft Compact Wide Blade Magnetic Tape Measure with 15' Reach*
48-22-0326	8m/26ft Compact Wide Blade Magnetic Tape Measure with 15' Reach*

## COMPACT TAPE MEASURES

**12' REACH\***

Impact Resistant Frame  
5-Point Reinforced

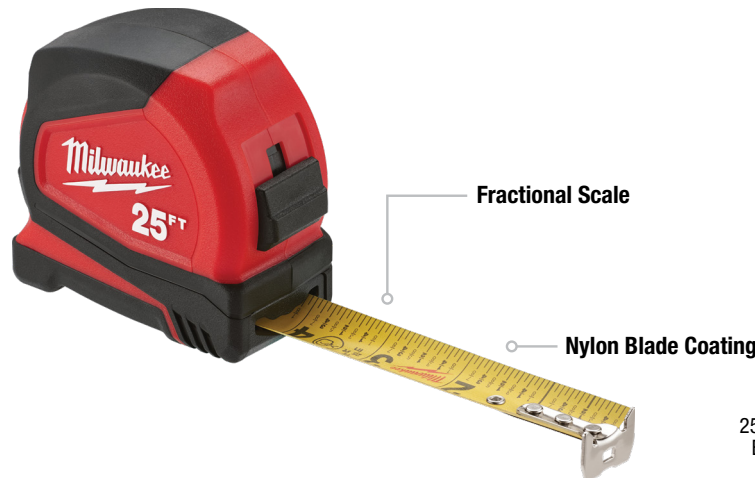

Also Available:



25ft Compact Tape Measure with Engineer Scale with 12' Reach\*  
48-22-6625E



Nylon Blade Coating

Model #	Description
48-22-6612	12ft Compact Tape Measure with 12' Reach*
48-22-6616	16ft Compact Tape Measure with 12' Reach*
48-22-6625	25ft Compact Tape Measure with 12' Reach*
48-22-6630	30ft Compact Tape Measure with 12' Reach*
48-22-6613	3m/12ft Compact Tape Measure with 12' Reach*
48-22-6617	5m/16ft Compact Tape Measure with 12' Reach*
48-22-6626	8m/26ft Compact Tape Measure with 12' Reach*

Model #	Description
48-22-6816	16ft Compact Auto-Lock Tape Measure with 12' Reach*
48-22-6825	25ft Compact Auto-Lock Tape Measure with 12' Reach*
48-22-6817	5m/16ft Compact Auto-Lock Tape Measure with 12' Reach*
48-22-6826	8m/26ft Compact Auto-Lock Tape Measure with 12' Reach*
48-22-5506	2m/6ft Keychain Tape Measure
48-22-6601	10ft/3m Keychain Tape Measure with LED

## OPEN REEL LONG TAPES

### 50% LESS STRETCH

**3:1 Metal Planetary Gears**  
Prevents gear stripping & stress



**GRIME GUARD™ Blade Wiper**  
Smoothest retraction

**Nylon Bond**  
**Kink-Resistant Blade**  
**2-Sided Printing**

## FIBERGLASS LONG TAPES

### SMOOTHEST RETRACTION

**3:1 Metal Planetary Gears**  
Prevents gear stripping & stress



**GRIME GUARD™ Blade Wiper**  
Smoothest retraction

**2-Sided Printing**

Model #	Description
48-22-5201	100ft Open Reel Steel Long Tape
48-22-5230	300ft Open Reel Steel Long Tape

Model #	Description
48-22-5301	100ft Fiberglass Open Reel Long Tape
48-22-5302	200ft Fiberglass Open Reel Long Tape
48-22-5303	300ft Fiberglass Open Reel Long Tape
48-22-5310	100m/330ft Fiberglass Open Reel Long Tape
48-22-5330	30m/100ft Fiberglass Open Reel Long Tape
48-22-5360	60m/200ft Fiberglass Open Reel Long Tape

## CLOSED REEL LONG TAPE

### LONGEST LIFE

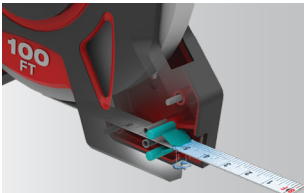

**GRIME GUARD™**  
Industry's First Blade Wiper

**3:1 Torque Dispersing Planetary Gears**  
Prevents gear stripping & stress

**Reinforced Metal Frame**



**GRIME GUARD™ Blade Wiper**  
Smoothest retraction

**Nylon Coated Blade**  
**2-Sided Printing**

Model #	Description
48-22-5101	100ft Closed Reel Long Tape

## MEASURING WHEELS

### MOST DURABLE. MOST ACCURATE.

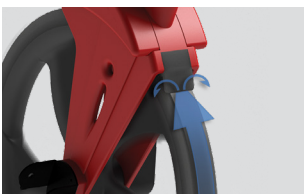

**Debris Cleaning Wheel Flap**

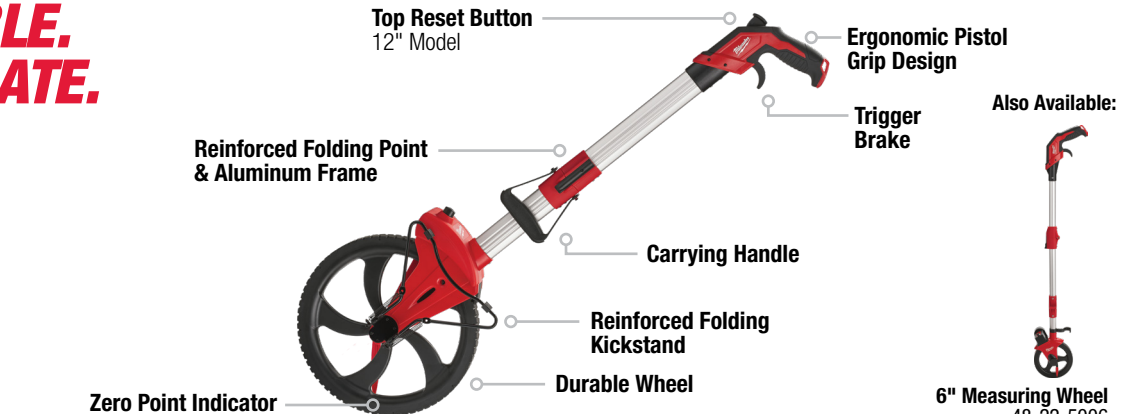

Model #	Description
48-22-5012	12" Measuring Wheel
48-22-5013	12" Engineer's Measuring Wheel

Model #	Description
48-22-5006	6" Measuring Wheel



# REDSTICK™ CONCRETE LEVELS & TORPEDO LEVELS

## REDSTICK™ DIGITAL LEVELS

**SUPERIOR ACCURACY.  
DYNAMIC READOUT.**

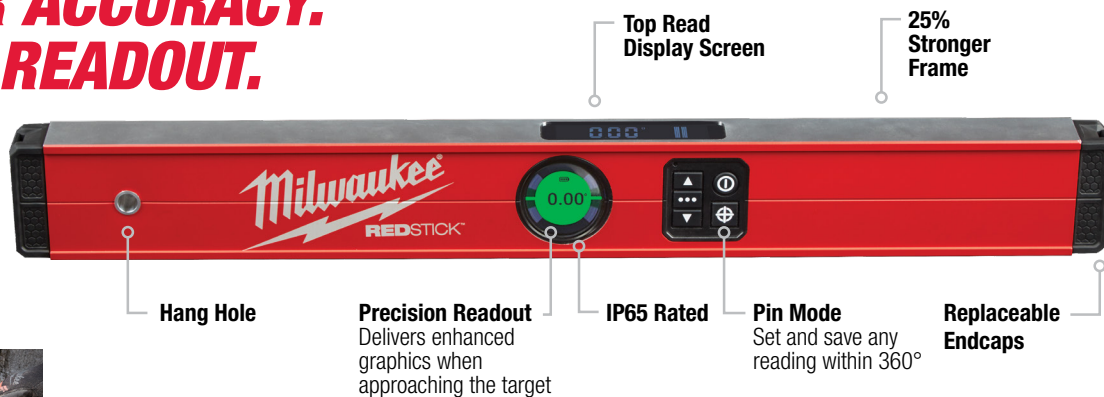

**PINPOINT™ Measurement Technology**

Model #	Description
MLDIG14	14" REDSTICK™ Digital Level with PINPOINT™ Measurement Technology
MLDIG24	24" REDSTICK™ Digital Level with PINPOINT™ Measurement Technology
MLDIG48	48" REDSTICK™ Digital Level with PINPOINT™ Measurement Technology
MLDIG72	72" REDSTICK™ Digital Level with PINPOINT™ Measurement Technology

## REDSTICK™ BOX LEVELS

**MOST DURABLE.  
GUARANTEED ACCURACY.**

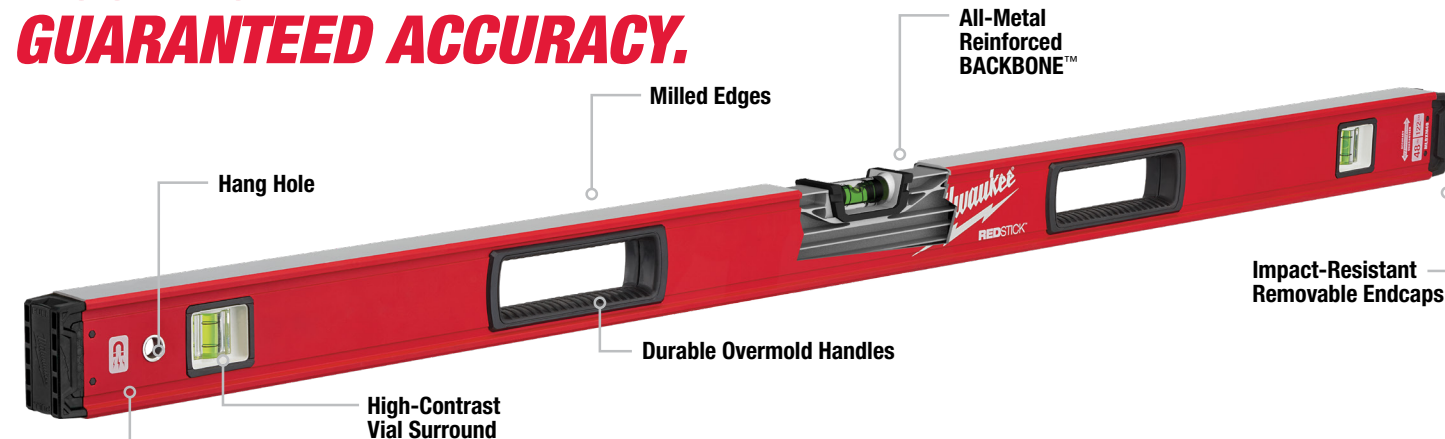

**Amplified Rare-Earth Magnets**

Model #	Description
MLBX16	16" REDSTICK™ Box Level
MLBXM16	16" REDSTICK™ Magnetic Box Level
MLBX24	24" REDSTICK™ Box Level
MLBXM24	24" REDSTICK™ Magnetic Box Level
MLBX32	32" REDSTICK™ Box Level
MLBXM32	32" REDSTICK™ Magnetic Box Level
MLBX36	36" REDSTICK™ Box Level
MLBXM36	36" REDSTICK™ Magnetic Box Level
MLBX48	48" REDSTICK™ Box Level
MLBXM48	48" REDSTICK™ Magnetic Box Level
MLBX59	59" REDSTICK™ Box Level
MLBXM59	59" REDSTICK™ Magnetic Box Level
MLBX72	72" REDSTICK™ Box Level
MLBXM72	72" REDSTICK™ Magnetic Box Level

Model #	Description
MLBX78	78" REDSTICK™ Box Level
MLBXM78	78" REDSTICK™ Magnetic Box Level
MLBX96	96" REDSTICK™ Box Level
MLBXM96	96" REDSTICK™ Magnetic Box Level
MLBXS1648	16" / 48" REDSTICK™ Box Level Set
MLBXS48	24" / 48" REDSTICK™ Box Level Set
MLBXS48M	24" / 48" REDSTICK™ Magnetic Box Level Set
MLBXJB	78" / 32" REDSTICK™ Box Level Jamb Set
MLBXJBM	78" / 32" REDSTICK™ Magnetic Box Level Jamb Set
MLSB48	48" Level Bag
MLSB78	78" Level Bag
MLBXC48	4 Pc REDSTICK™ Starter Set
MLBXC78	5 Pc REDSTICK™ Master Set

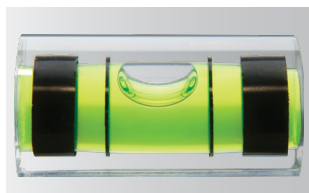

**SHARPSITE™ Vial Technology**

## REDSTICK™ COMPACT BOX LEVELS

### COMPACT DURABILITY

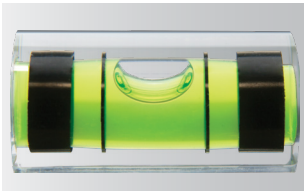

SHARPSITE™ Vial Technology

Model #	Description
MLCM24	24" REDSTICK™ Compact Box Level
MLCMM24	24" REDSTICK™ <b>Magnetic</b> Compact Box Level
MLCM48	48" REDSTICK™ Compact Box Level
MLCMM48	48" REDSTICK™ <b>Magnetic</b> Compact Box Level
MLCM72	72" REDSTICK™ Compact Box Level

Model #	Description
MLCMM72	72" REDSTICK™ <b>Magnetic</b> Compact Box Level
MLCMS48	24" / 48" REDSTICK™ Compact Box Level Set
MLCMSM48	24" / 48" REDSTICK™ <b>Magnetic</b> Compact Box Level Set

## REDSTICK™ EXPANDABLE LEVELS

### FRAME MORE. NO MAINTENANCE.



Reinforced Components & Durable Lock



Also Available:

Expandable Level Storage Bag  
MLXPSB

Model #	Description
MLXPM78	48" – 78" REDSTICK™ <b>Magnetic</b> Expandable Level
MLXP712	6-1/2' – 12' REDSTICK™ Expandable Level



# REDSTICK™ CONCRETE LEVELS & TORPEDO LEVELS

## REDSTICK™ CONCRETE LEVELS

### BUILT FOR CONCRETE



Screed



Smooth



Clean

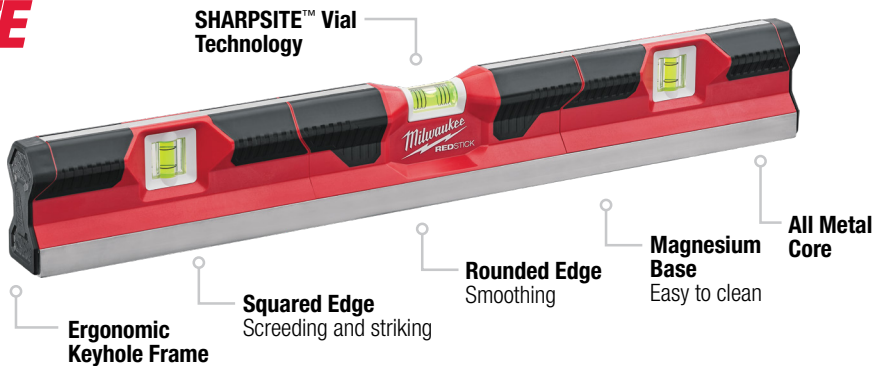

Model #	Description
MLCON24	24" REDSTICK™ Concrete Level
MLCON48	48" REDSTICK™ Concrete Level
MLCON72	72" REDSTICK™ Concrete Level

## BILLET TORPEDO LEVELS

### STRONGEST MAGNETS. EASIEST PITCH SET.



4 Amplified Rare-Earth Magnets

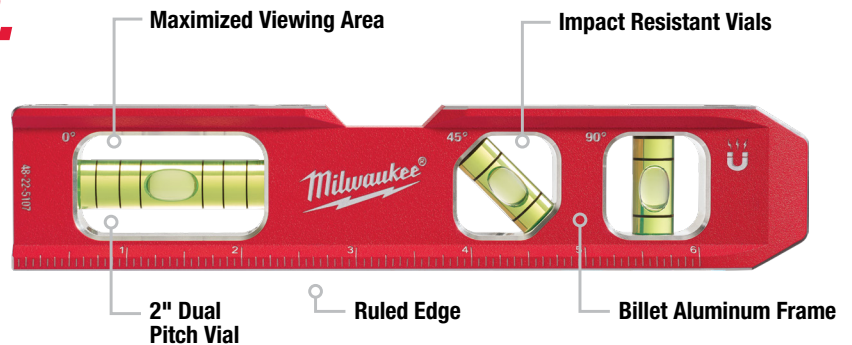

Model #	Description
48-22-5107	Billet Torpedo Level
48-22-5207	Metric Billet Torpedo Level

## BLOCK TORPEDO LEVEL

### STRONGEST MAGNETS. 360° ACCURACY.



Amplified Rare-Earth Magnets

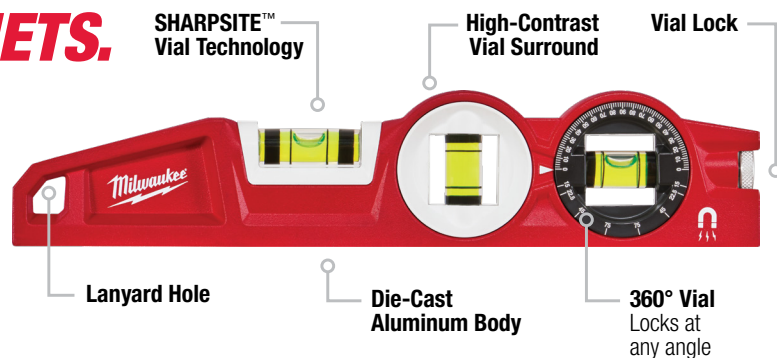

Model #	Description
48-22-5210	Block Torpedo Level
48-22-5102	360° Pocket Level

Model #	Description
48-22-5603	Pocket Level
48-22-5001	Pipe Lock Level

## RAFTER SQUARES

**STRONGER FRAME.  
MOST VERSATILE.**

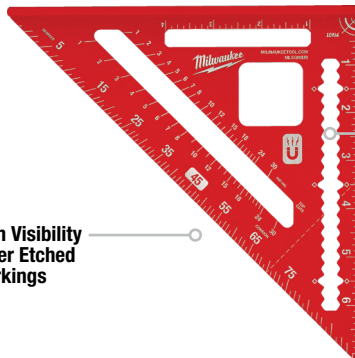

High Visibility Laser Etched Markings

Scribe Notches

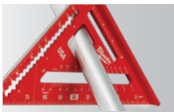

1" Cutout Props Pipe

Model #	Description
MLSQM070	7" Magnetic Rafter Square
MLSQ170	180mm Rafter Square

## TRIM SQUARE

**MOST COMPACT.  
MOST VERSATILE.**

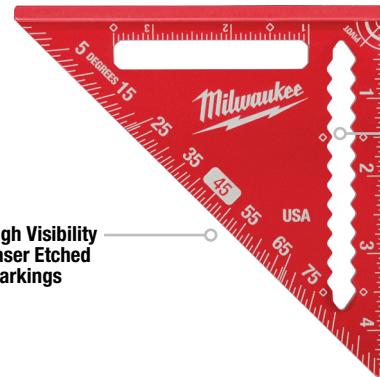

High Visibility Laser Etched Markings

Precision Scribe Notches at 1/8" Increments



Dual Reference Heel

Model #	Description
MLSQ040	4-1/2" Trim Square

## FRAMING SQUARES

**STRONGER THAN STEEL.  
MOST VERSATILE.**

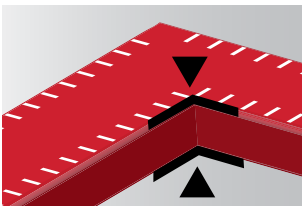

Thicker Frame

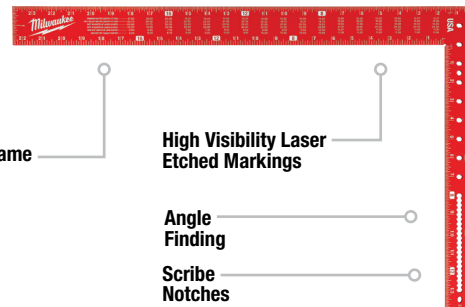

Reinforced Frame

High Visibility Laser Etched Markings

Angle Finding

Scribe Notches

Model #	Description
MLSQ024	16" x 24" Framing Square
MLSQ124	400mm x 600mm Framing Square

## LASER DISTANCE METERS

**EASIEST  
MEASUREMENTS**



Simplified User Interface

2" Backlit Color Screen

Continuous Real-Time Measurements

2-Position Auto-Detecting Lever



Impact-Resistant Overmolding

Side-Shot Button  
Allows for one-handed measurement in all situations

Also Available:



65ft Laser Distance Meter  
48-22-9801

Model #	Description
48-22-9801	65ft Laser Distance Meter
48-22-9802	150ft Laser Distance Meter

Model #	Description
48-22-9803	330ft Laser Distance Meter



# FOLDING RULES & CHALK REELS

## FOLDING RULES

### MOST DURABLE MARKINGS & BLADES

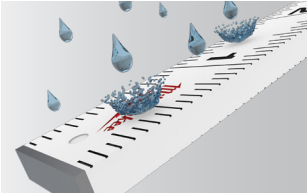

Water & Scratch Resistant Laminate

**Quick Reference Bend Angles**  
22.5°, 30°, 45° & 60°

**Heat-Stamped Markings**  
Won't wear



**Corrosion-Free Embedded Joints**  
Locks at 0°, 90° & 180°

Model #	Description
48-22-3801	6-1/2ft Composite Folding Rule
48-22-3802	6-1/2ft Engineer's Composite Folding Rule

## CHALK REELS

### LONGEST GEAR LIFE. BEST PERFORMANCE.



**Bold Line**

1.5mm High-Strength Braided Line

6X Faster Retraction



**Fine Line**

0.9mm High-Strength Braided Line

Aluminum Body  
Fine line model only



StripGuard™ Clutch & Planetary Gears

Model #	Description
48-22-3980	100ft Bold Line Chalk Reel
48-22-3982	100ft Bold Line Chalk Reel & Blue Chalk Refill
48-22-3986	100ft Bold Line Chalk Reel & Red Chalk Refill
48-22-3989	Bold Replacement Line

Model #	Description
48-22-3990	100ft Fine Line Chalk Reel
48-22-3992	100ft Fine Line Chalk Reel & Blue Chalk Refill
48-22-3993	100ft Chalk Reel Kit with Blue Chalk Refill
48-22-3999	Fine Replacement Line

## EXTRA BOLD LARGE CAPACITY CHALK REELS

### LONGEST GEAR LIFE. BEST PERFORMANCE.



Planetary Gears Prevent Stripping

24oz Chalk Capacity

4:1 Retraction Speed

Refillable Base



Easy Grip Metal Handle

Quick Turn Opening

Model #	Description
48-22-3910	100ft Extra Bold Large Capacity Chalk Reel
48-22-3900	100ft Extra Bold Replacement Line

Model #	Description
48-22-3915	150ft Extra Bold Large Capacity Chalk Reel
48-22-3905	150ft Extra Bold Replacement Line

## INKZALL™ JOBSITE MARKERS

**WRITES ON  
DUST  
WET  
OILY  
SURFACES**



**Clog Resistant**



**Up to 72 Hour  
Cap-Off Life**



Model #	Description
48-22-3150	12 Pc INKZALL™ Ultra Fine Point Black Jobsite Markers
48-22-3154	4 Pc INKZALL™ Ultra Fine Point Black Jobsite Markers
48-22-3104	4 Pc INKZALL™ Fine Point Black Jobsite Markers
48-22-3105	2 Pc INKZALL™ Fine Point Black Jobsite Markers
48-22-3107	8 Pc INKZALL™ Fine Point Color Jobsite Markers
48-22-3106	4 Pc INKZALL™ Fine Point Color Jobsite Markers
48-22-3101	INKZALL™ Stylus and Fine Point Black Jobsite Markers
48-22-3102	2 Pc INKZALL™ Medium Point Black Jobsite Markers
48-22-3103	INKZALL™ Chisel Tip Black Jobsite Markers
48-22-3109	4 Pc INKZALL™ Chisel Tip Color Jobsite Markers
48-22-3100	INKZALL™ Fine Point Black Jobsite Markers (Bulk 36 Pc)
48-22-3130	INKZALL™ Chisel Tip Black Jobsite Markers (Bulk 36 Pc)

Model #	Description
48-22-3170	INKZALL™ Fine Point Red Jobsite Markers (Bulk 36 Pc)
48-22-3180	INKZALL™ Fine Point Blue Jobsite Markers (Bulk 36 Pc)
48-22-3190	INKZALL™ Fine Point Green Jobsite Markers (Bulk 36 Pc)
48-22-3209	12 Pc INKZALL™ Fine Point Black Jobsite Markers
48-22-3250	3 Pc INKZALL™ Large Chisel Tip Black Jobsite Markers
48-22-3255	INKZALL™ Large Chisel Tip Black Jobsite Markers (Bulk 12 Pc)
48-22-3256	INKZALL™ Large Chisel Tip Red Jobsite Markers (Bulk 12 Pc)
48-22-3257	INKZALL™ Large Chisel Tip Blue Jobsite Markers (Bulk 12 Pc)
48-22-3260	INKZALL™ Extra Large Chisel Tip Black Jobsite Markers
48-22-3265	INKZALL™ Extra Large Chisel Tip Black Jobsite Markers (Bulk 12 Pc)
48-22-3266	INKZALL™ Extra Large Chisel Tip Red Jobsite Markers (Bulk 12 Pc)
48-22-3267	INKZALL™ Extra Large Chisel Tip Blue Jobsite Markers (Bulk 12 Pc)

## INKZALL™ METALLIC MARKERS



**Visible on Dark Surfaces**



Model #	Description
48-22-3121	2 Pc INKZALL™ Fine Point Silver Metallic Marker
48-22-3122	2 Pc INKZALL™ Fine Point Gold Metallic Marker
48-22-3123	2 Pc INKZALL™ Fine Point Silver/Gold Metallic Marker



# INKZALL™ PAINT MARKERS, PENS & HIGHLIGHTERS

## INKZALL™ LIQUID PAINT MARKERS

**BLEED &  
SMEAR  
RESISTANT**



Marks on Surfaces up to 300°F

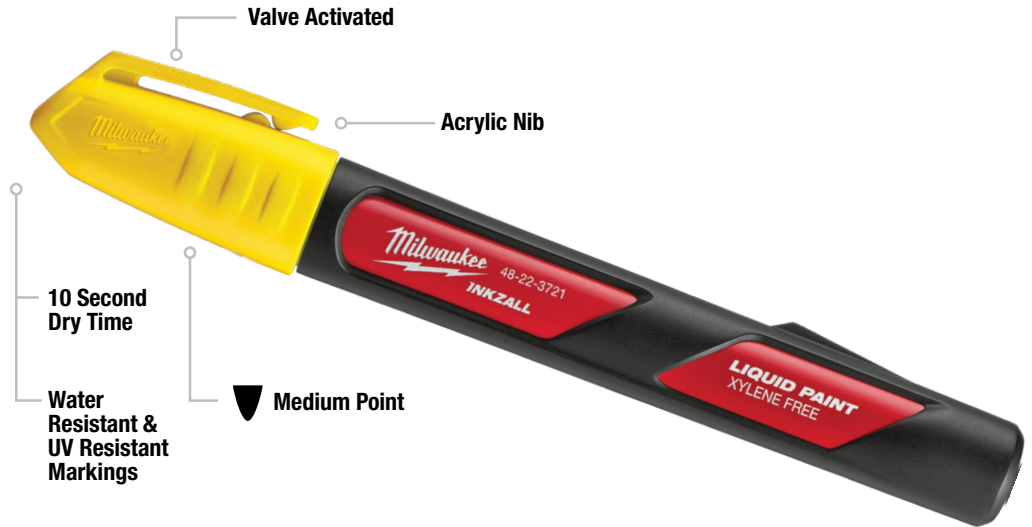

Model #	Description
48-22-3712	INKZALL™ Medium Point White Liquid Paint Marker
48-22-3722	INKZALL™ Medium Point Yellow Liquid Paint Marker
48-22-3711	INKZALL™ Medium Point White Liquid Paint Marker (Bulk 12 Pc)
48-22-3721	INKZALL™ Medium Point Yellow Liquid Paint Marker (Bulk 12 Pc)
48-22-3731	INKZALL™ Medium Point Black Liquid Paint Marker (Bulk 12 Pc)

Model #	Description
48-22-3741	INKZALL™ Medium Point Red Liquid Paint Marker (Bulk 12 Pc)
48-22-3751	INKZALL™ Medium Point Green Liquid Paint Marker (Bulk 12 Pc)
48-22-3761	INKZALL™ Medium Point Blue Liquid Paint Marker (Bulk 12 Pc)
48-22-3771	INKZALL™ Medium Point Orange Liquid Paint Marker (Bulk 12 Pc)

## INKZALL™ JOBSITE PENS

**SHARP,  
PRECISE  
LINES**



Model #	Description
48-22-3160	12 Pc INKZALL™ Ultra Fine Point Black Jobsite Pen
48-22-3161	12 Pc INKZALL™ Ultra Fine Point Red Jobsite Pen
48-22-3162	12 Pc INKZALL™ Ultra Fine Point Blue Jobsite Pen
48-22-3164	4 Pc INKZALL™ Ultra Fine Point Black Jobsite Pen
48-22-3165	4 Pc INKZALL™ Ultra Fine Point Color Jobsite Pen

## INKZALL™ JOBSITE HIGHLIGHTERS

**UP TO  
4X LONGER LIFE**



Model #	Description
48-22-3201	5 Pc INKZALL™ Chisel Tip Yellow Jobsite Highlighter
48-22-3206	5 Pc INKZALL™ Chisel Tip Colored Jobsite Highlighter

## COMFORT GRIP STRAIGHT JAW PLIERS

**REAM  
AND PUNCH™**



Ream

Punch



Model #	Description	Jaw Capacity	Reaming Capacity
48-22-6306	6" Comfort Grip Straight Jaw Pliers	1"	3/4"
48-22-6310	10" Comfort Grip Straight Jaw Pliers	2"	2"
48-22-6312	12" Comfort Grip Straight Jaw Pliers	2-1/4"	2-3/4"
48-22-6316	16" Comfort Grip Straight Jaw Pliers	4-1/4"	3"
48-22-6320	20" Comfort Grip Straight Jaw Pliers	5-1/2"	3-1/2"
48-22-6330	2 Pc 6" & 10" Comfort Grip Straight Jaw Pliers Set	1" & 2"	3/4" & 2"
48-22-6331	3 Pc Comfort Grip Pliers Set	2"	2"

## STRAIGHT JAW PLIERS

**MAXIMUM GRIP.  
FORGED STRENGTH.**



Reaming Head

Model #	Description	Jaw Capacity	Reaming Capacity
48-22-6510	10" Straight Jaw Pliers	2"	2"
48-22-6512	12" Straight Jaw Pliers	2-1/4"	2-3/4"

## SMOOTH JAW PLIERS

**SMOOTH JAW  
PROTECTS SURFACES**



Non-Marring Smooth Jaw  
for Finish Applications

Model #	Description	Jaw Capacity	Reaming Capacity
48-22-6550	10" Smooth Jaw Pliers	2"	2"
48-22-6552	12" Smooth Jaw Pliers	2-1/4"	2-3/4"

# FASTENING & CUTTING PLIERS

## V-JAW PLIERS

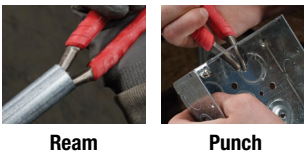

Model #	Description	Jaw Capacity	Reaming Capacity
48-22-6208	8" Comfort Grip V-Jaw Pliers	1-1/2"	1-1/2"
48-22-6210	10" Comfort Grip V-Jaw Pliers	2"	2"
48-22-6212	12" Comfort Grip V-Jaw Pliers	2-3/4"	2-3/4"

## LINEMAN'S PLIERS

**MAXIMUM LEVERAGE.**  
**EASIER CUTS.\***



Model #	Description
48-22-6100	Comfort Grip High-Leverage Lineman's Pliers with Crimper
48-22-6500	High-Leverage Lineman's Pliers with Crimper
48-22-6502	High-Leverage Lineman's Pliers
48-22-6503	High-Leverage Lineman's Pliers with Thread Cleaner

## ANGLED HEAD PLIERS

**BETTER ACCESS**



Model #	Description
48-22-6128	8" Comfort Grip Angled Head Diagonal Cutting Pliers
48-22-6528	8" Angled Head Diagonal Cutting Pliers

\* When compared to other ACSR cutting lineman pliers



## LONG NOSE PLIERS

### LONG REACH



2" Gripping Nose

Also Available:



8" Long Nose Pliers  
48-22-6501

Model #	Description
48-22-6101	8" Comfort Grip Long Nose Pliers
48-22-6501	8" Long Nose Pliers

## DIAGONAL PLIERS

UP TO **2X MORE CUTS**

**IRON-CARBIDE EDGE**



Tapered Nose

Also Available:



8" Diagonal Cutting Pliers  
48-22-6508

Model #	Description
48-22-6106	6" Comfort Grip Diagonal Cutting Pliers
48-22-6107	7" Comfort Grip Diagonal Cutting Pliers
48-22-6108	8" Comfort Grip Diagonal Cutting Pliers
48-22-6508	8" Diagonal Cutting Pliers

# COMBINATION & MULTI-FUNCTION PLIERS

## 6IN1 COMBINATION PLIERS

**6IN1**

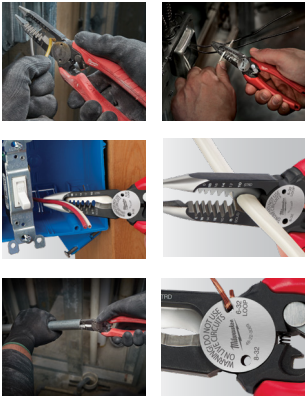
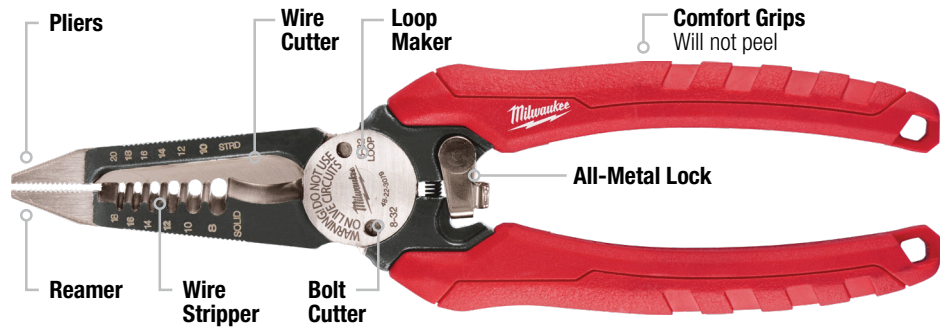

Model #	Description	Wire Stripper
48-22-3079	6IN1 Comfort Grip Combination Pliers	8-18 AWG Solid, 10-20 AWG Stranded

## MULTI-FUNCTION PLIERS

**FAST, ONE-HANDED OPERATION**

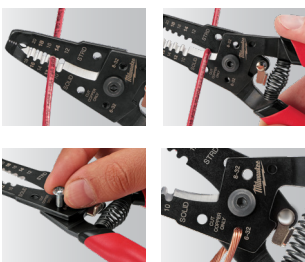
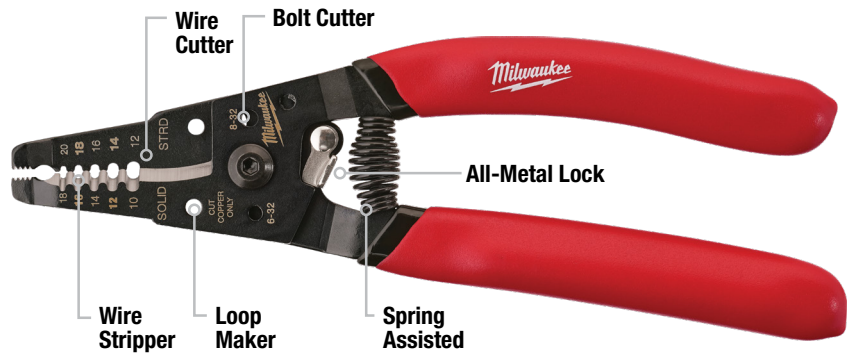

Model #	Description	Wire Stripper
48-22-6109	Wire Stripper	10-18 AWG Solid, 12-20 AWG Stranded
48-22-6579	Multi-Purpose Wire Stripper with Crimper	10-20 AWG Solid, 12-22 AWG Stranded

## IRONWORKER'S PLIERS

UP TO **2X MORE CUTS**

**IRON-CARBIDE EDGE**

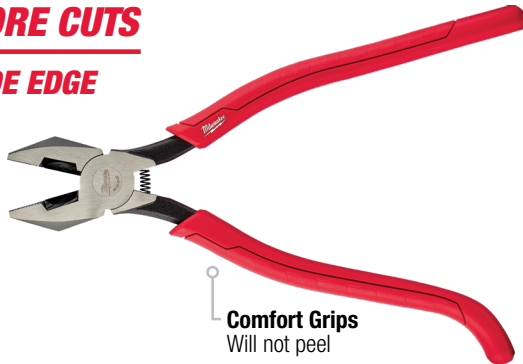

Comfort Grips  
Will not peel



For Twisting & Cutting Rebar Ties

Model #	Description
48-22-6102	Ironworker's Pliers

## CRIMPING PLIERS

UP TO **2X CRIMPING FORCE**



Reaming Head Wire Cutter

Comfort Grips  
Will not peel



Crimper for Insulated & Non-Insulated Terminals

Model #	Description
48-22-6103	Crimping Pliers

## CABLE CUTTING PLIERS

**CLEAN CUTS**



Comfort Grips  
Will not peel



Cuts up to 2/0 Cu, 4/0 Al

Model #	Description
48-22-6104	Cable Cutting Pliers

## PVC / OIL FILTER PLIERS

**3-1/2" JAW CAPACITY**



Comfort Grips  
Will not peel



Model #	Description
48-22-6321	PVC / Oil Filter Pliers

## NIPPING PLIERS

**CURVED HEAD. PROTECTS SURFACES.**



Comfort Grips  
Will not peel



Blades Will Not Mar Surfaces

Model #	Description
48-22-6407	7" Nipping Pliers

## FENCING PLIERS

**FORGED STRENGTH**

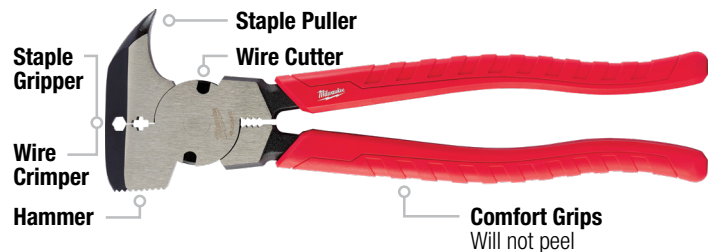

Staple Puller Wire Cutter  
Wire Crimper Hammer

Comfort Grips  
Will not peel



Wire Puller

Model #	Description
48-22-6410	Fencing Pliers



# TORQUE LOCK™ PLIERS, C-CLAMPS & SPECIALTY

## TORQUE LOCK™ FASTER SET-UP

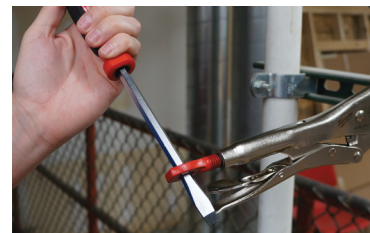

### LOCKING PLIERS WITH MAX BITE™

#### MAX BITE™ 3X GRIPPING FORCE



**CHROME**  
Chrome plated rust protection



**GRIPPED**  
Rubber overmold

Model #	Description
48-22-3607	7" TORQUE LOCK™ MAX BITE™ Curved Jaw Locking Pliers
48-22-3610	10" TORQUE LOCK™ MAX BITE™ Curved Jaw Locking Pliers
48-22-3702	2 Pc 7" & 10" TORQUE LOCK™ MAX BITE™ Curved Jaw Locking Pliers

Model #	Description
48-22-3710	10" TORQUE LOCK™ MAX BITE™ Curved Jaw Locking Pliers With Grip
48-22-3707	7" TORQUE LOCK™ MAX BITE™ Curved Jaw Locking Pliers With Grip

### LOCKING PLIERS



**CURVED JAW**  
Maximizes pressure points for any bolt, nut or locking tool application



**STRAIGHT JAW**  
Maximizes contact points on jobsite work surfaces



**LONG NOSE**  
Best for long reach applications

Model #	Description
48-22-3405	5" TORQUE LOCK™ Curved Jaw Locking Pliers with Grip
48-22-3407	7" TORQUE LOCK™ Curved Jaw Locking Pliers with Grip
48-22-3410	10" TORQUE LOCK™ Curved Jaw Locking Pliers with Grip
48-22-3406	6" TORQUE LOCK™ Long Nose Locking Pliers with Grip
48-22-3409	9" TORQUE LOCK™ Long Nose Locking Pliers with Grip
48-22-3807	7" TORQUE LOCK™ Straight Jaw Locking Pliers with Grip
48-22-3810	10" TORQUE LOCK™ Straight Jaw Locking Pliers with Grip
48-22-3402	2 Pc 7" & 10" TORQUE LOCK™ Curved Jaw Locking Pliers with Grip Set
48-22-3602	2 Pc. 10" Curved Jaw & 6" Long Nose TORQUE LOCK™ Locking Pliers Set
48-22-3423	4" TORQUE LOCK™ Curved Jaw Locking Pliers

Model #	Description
48-22-3422	5" TORQUE LOCK™ Curved Jaw Locking Pliers
48-22-3421	7" TORQUE LOCK™ Curved Jaw Locking Pliers
48-22-3420	10" TORQUE LOCK™ Curved Jaw Locking Pliers
48-22-3504	4" TORQUE LOCK™ Long Nose Locking Pliers
48-22-3506	6" TORQUE LOCK™ Long Nose Locking Pliers
48-22-3507	7" TORQUE LOCK™ Straight Jaw Locking Pliers
48-22-3509	9" TORQUE LOCK™ Long Nose Locking Pliers
48-22-3510	10" TORQUE LOCK™ Straight Jaw Locking Pliers
48-22-3541	12" TORQUE LOCK™ Large Jaw Locking Pliers

### C-CLAMPS & SPECIALTY

#### STANDARD JAW C-CLAMP

Greater clamping versatility on a variety of shapes and surfaces



#### SWIVEL JAW C-CLAMP

Pads provide surface stabilization and protect work surfaces from damage



Model #	Description
48-22-3521	11" TORQUE LOCK™ Swivel Jaw Locking C-Clamp
48-22-3522	6" TORQUE LOCK™ Swivel Jaw Locking C-Clamp
48-22-3531	11" TORQUE LOCK™ Locking C-Clamp
48-22-3532	6" TORQUE LOCK™ Locking C-Clamp
48-22-3520	18" TORQUE LOCK™ Swivel Jaw Locking C-Clamp
48-22-3529	18" TORQUE LOCK™ Deep Reach Locking C-Clamp
48-22-3530	18" TORQUE LOCK™ Locking C-Clamp

Model #	Description
48-22-3540	8" TORQUE LOCK™ Locking Seamer
48-22-3542	9" TORQUE LOCK™ Locking Chain Wrench
48-22-3543	9" TORQUE LOCK™ Locking Welding Clamp
48-22-3523	9" TORQUE LOCK™ Deep Reach Swivel Jaw Locking C-Clamp
48-22-3533	9" TORQUE LOCK™ Deep Reach Locking C-Clamp
48-22-3631	11" TORQUE LOCK™ Locking C-Clamp
48-22-3632	6" TORQUE LOCK™ Locking C-Clamp

## 2IN1 LINEMAN'S INSULATED RATCHETING BOX WRENCH

**DURABLE, FORGED STEEL.  
1000V INSULATED.**



9/16" and 3/4" Twelve Point Sockets

Model #	Description
48-22-9211	Lineman's 2in1 Insulated Ratcheting Box Wrench

## 4IN1 LINEMAN'S INSULATED RATCHETING BOX WRENCH

**DURABLE, FORGED STEEL.  
1000V INSULATED.**

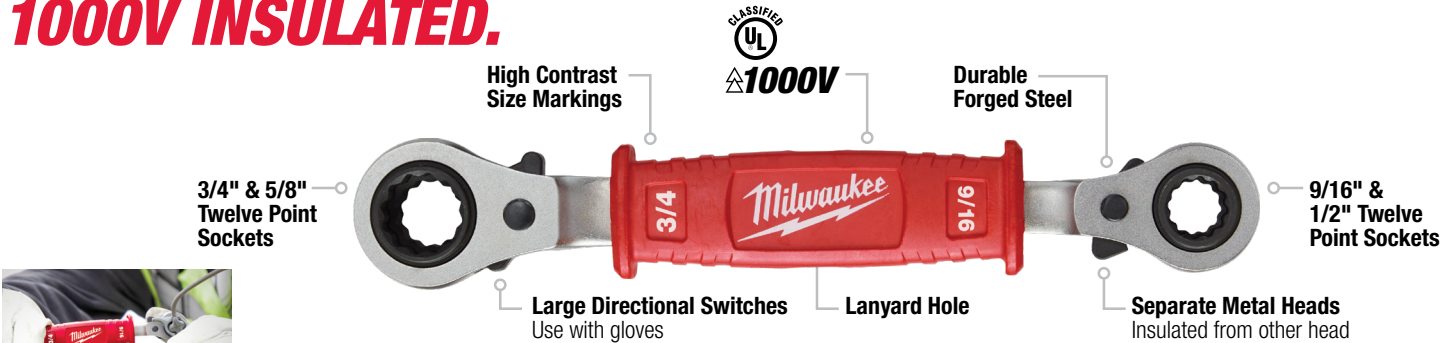

Ergonomic Handle

Model #	Description
48-22-9212	Lineman's 4in1 Insulated Ratcheting Box Wrench

## POWER UTILITY WRENCH

**MOST DURABLE RATCHET.  
BUILT IN HAMMER.**



Durable Forged Steel

Model #	Description
48-22-9213	Lineman's High-Leverage Ratcheting Wrench with Smooth Strike Face

# POWER UTILITY WRENCH & PIPE WRENCHES

## POWER UTILITY WRENCH

**MOST DURABLE RATCHET.  
BUILT IN HAMMER.**

3/4" & 1-1/8" Square

**Built-In-Hammer**  
Dedicated surface for hammering

Durable Forged Steel

Laser Etched Size Markings

9/16" & 3/4" Twelve Point Sockets

Lanyard Hole



Large Directional Switches

Model #	Description
48-22-9216	5in1 Lineman's Ratcheting Wrench with Smooth Strike Face

## CHEATER ADAPTABLE PIPE WRENCH

**3 LENGTH DESIGN**



**Dual Coil Spring Design**  
Increased durability and life



**OVERBITE JAW™**  
Largest Gripping Surface

Lanyard Hole

Threaded Fit & Security



Model #	Description	Material	Max Jaw Capacity
48-22-7314	CHEATER Adaptable Pipe Wrench	Steel	2-1/2"

## 10L ALUMINUM PIPE WRENCH WITH POWERLENGTH™ HANDLE

**BETTER ACCESS.  
MAXIMUM LEVERAGE.**



Lanyard Hole



Model #	Description	Material	Max Jaw Capacity
48-22-7313	10L Aluminum Pipe Wrench w/POWERLENGTH™ Handle	Aluminum	1-1/2"



## STEEL & ALUMINUM PIPE WRENCHES

**LARGEST GRIP SURFACE**



Steel



Aluminum

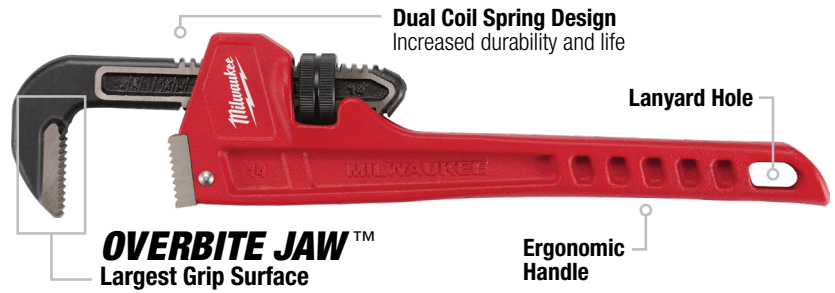

Model #	Description	Length	Material	Max Jaw Capacity
48-22-7106	6" Steel Pipe Wrench	6"	Steel	3/4"
48-22-7108	8" Steel Pipe Wrench	8"	Steel	1"
48-22-7110	10" Steel Pipe Wrench	10"	Steel	1-1/2"
48-22-7112	12" Steel Pipe Wrench	12"	Steel	2"
48-22-7114	14" Steel Pipe Wrench	14"	Steel	2"
48-22-7118	18" Steel Pipe Wrench	18"	Steel	2-1/2"
48-22-7124	24" Steel Pipe Wrench	24"	Steel	3"
48-22-7136	36" Steel Pipe Wrench	36"	Steel	5"

Model #	Description	Length	Material	Max Jaw Capacity
48-22-7148	48" Steel Pipe Wrench	48"	Steel	6"
48-22-7160	60" Steel Pipe Wrench	60"	Steel	8"
48-22-7210	10" Aluminum Pipe Wrench	10"	Aluminum	1-1/2"
48-22-7212	12" Aluminum Pipe Wrench	12"	Aluminum	2"
48-22-7214	14" Aluminum Pipe Wrench	14"	Aluminum	2"
48-22-7218	18" Aluminum Pipe Wrench	18"	Aluminum	2-1/2"
48-22-7224	24" Aluminum Pipe Wrench	24"	Aluminum	3"
48-22-7236	36" Aluminum Pipe Wrench	36"	Aluminum	5"
48-22-7248	48" Aluminum Pipe Wrench	48"	Aluminum	6"

## STEEL OFFSET HEX PIPE WRENCH

**SMOOTH JAW WON'T MAR SURFACES**



Protects Chrome Surfaces

- Offset Jaw**  
Better Access
- Secure Grip**  
Up to 3 points of contact
- Smooth Jaws**



Model #	Description	Material	Max Jaw Capacity
48-22-7171	Steel Offset Hex Pipe Wrench	Steel	2-5/8"

## STEEL SMOOTH JAW PIPE WRENCH

**SMOOTH JAW PROTECTS SURFACES**



Protects Chrome Surfaces



Model #	Description	Material	Max Jaw Capacity
48-22-7186	12" Steel Smooth Jaw Pipe Wrench	Steel	2-5/8"

# PIPE WRENCHES & MULTI BIT DRIVERS

## ALUMINUM OFFSET HEX PIPE WRENCHES

### BETTER ACCESS



Offset Head

Model #	Description	Material	Max Jaw Capacity
48-22-7184	14" Aluminum Offset Pipe Wrench	Aluminum	2"
48-22-7185	18" Aluminum Offset Pipe Wrench	Aluminum	2"
48-22-7182	24" Aluminum Offset Pipe Wrench	Aluminum	3"

## 9IN1 MULTI-BIT / KEY DRIVERS

### 9IN1

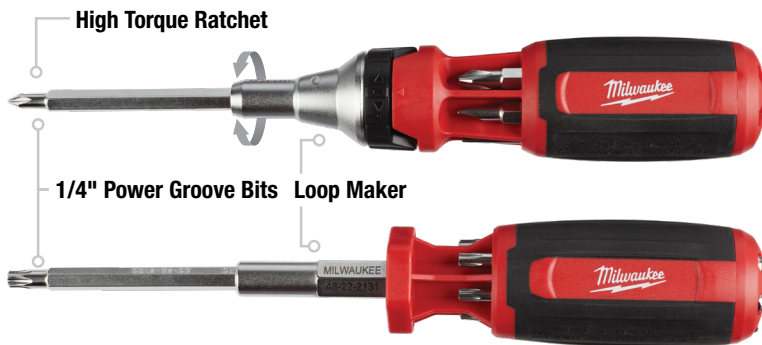

Power Tool Compatibility



In-Handle Storage

Model #	Description	Nut Drivers	Bit Types
48-22-2131	9in1 Multi-Bit Driver w/ ECX™	1/4"	P#1, P#2, SL 3/16", SL 1/4", SQ#1, SQ#2, ECX™#1, ECX™#2
48-22-2132	9in1 Square Multi-Bit Driver	1/4"	P#1, P#2, SL 3/16", SL 1/4", SQ#1, SQ#2, SQ#3
48-22-2331	9in1 Ratchet Multi-Bit Driver w/ ECX™	1/4"	P#1, P#2, SL 3/16", SL 1/4", SQ#2, ECX™#1, ECX™#2
48-22-2322	9in1 Ratchet Multi-Bit Driver w/ Square	1/4"	P#1, P#2, SL 3/16", SL 1/4", SQ#1, SQ#2, SQ#3
48-22-2133	9in1 TORX® Key Driver	1/4"	T8, T10, T15, T20, T25, T27, T30
48-22-2134	9in1 SAE Hex Key Driver	1/4"	7/64", 1/8", 9/64", 5/32", 3/16", 7/32", 1/4"
48-22-2136	9in1 Metric Hex Key Driver	1/4"	1.5mm, 2mm, 2.5mm, 3mm, 4mm, 5mm, 6mm
48-22-2110	4 Pc Replacement Bit Set		P#1, P#2, SL 3/16", SL 1/4", SQ #1, SQ#1, ECX™#1

## 8IN1 COMPACT MULTI-BIT DRIVERS

### 8IN1



Power Tool Compatibility



In-Handle Storage



Model #	Description	Nut Drivers	Bit Types
48-22-2130	Compact 8in1 Multi-Bit Driver	1/4"	P#1, P#2, SL 3/16", SL 1/4", SQ#1, SQ#2, T15
48-22-2330	Compact 8in1 Ratchet Multi-Bit Driver	1/4"	P#1, P#2, SL 3/16", SL 1/4", SQ#1, SQ#2, T15

## ADJUSTABLE WRENCHES

**JAWS WON'T  
BACK OFF**  
*Proprietary Screw*

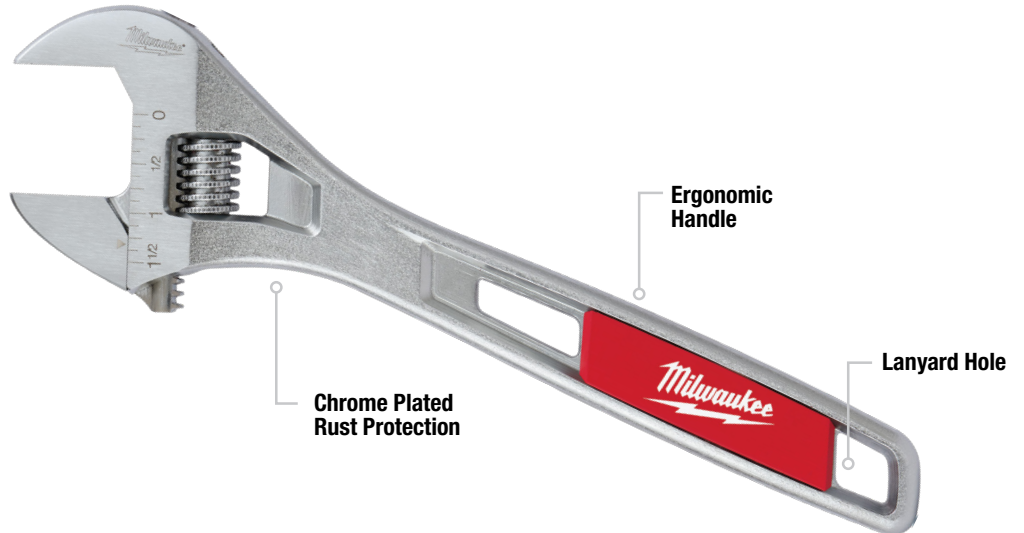
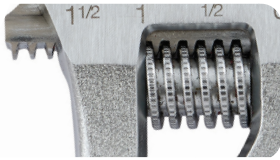

**Perfectly Parallel Jaws**

Model #	Description
48-22-7400	2 Pc 6" & 10" Adjustable Wrench Set
48-22-7406	6" Adjustable Wrench
48-22-7408	8" Adjustable Wrench
48-22-7410	10" Adjustable Wrench
48-22-7412	12" Adjustable Wrench
48-22-7415	15" Adjustable Wrench
48-22-7508	8" Wide Jaw Adjustable Wrench

## BASIN WRENCHES

**EASIEST  
SWAP-OUTS**



**Ratchet-Ready**  
Less jaw readjusting



**Screwdriver-Ready**  
Up to 2X breakaway torque

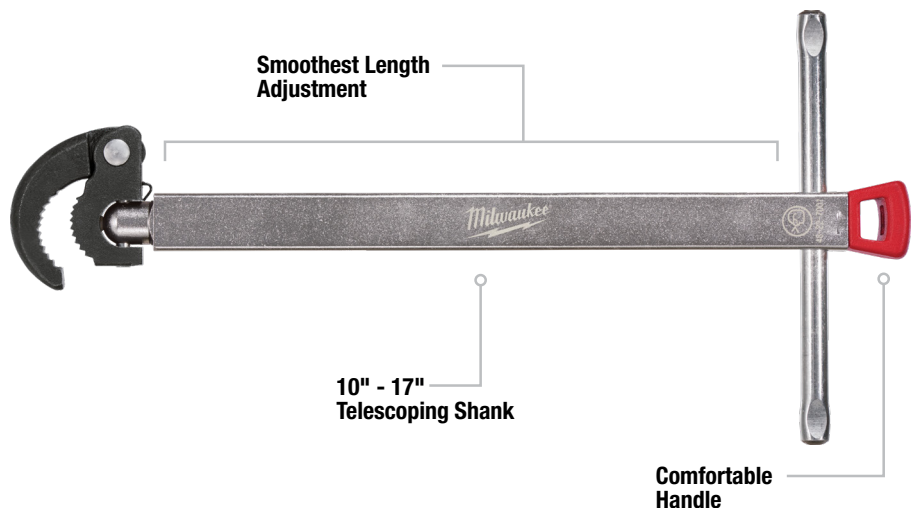

Model #	Description
48-22-7001	1-1/4" Basin Wrench
48-22-7002	2-1/2" Basin Wrench



## CONTRACTOR RATCHET & SOCKET SETS

**VERSATILE DESIGN.  
BETTER ACCESS.**

**SAE** **METRIC**



**FOUR FLAT™ SIDES**  
Anti-Roll, Wrench-Ready.

**Slim Design**



**Pivoting Head**

Model #	Description
48-22-9000	12 Pc 3/8" SAE Contractor Ratchet & Socket Set with FOUR FLAT™ Sides
48-22-9001	12 Pc 3/8" Metric Contractor Ratchet & Socket Set with FOUR FLAT™ Sides

## MECHANICS RATCHET & SOCKET SETS

**MOST VERSATILE SOCKETS.  
ANTI-ROLL, WRENCH-READY.**

**SAE** **METRIC**

**Stamped Sizes**  
Better visibility



**Anti-Roll**

**Wrench-Ready**



**90° Tooth Design**

**Slim Design**  
Access tight spaces

**4° ARC SWING**

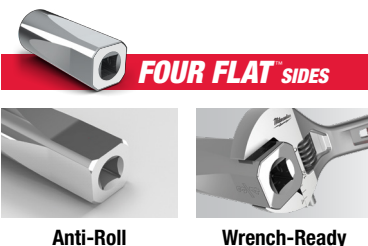

**FOUR FLAT™ SIDES**

**Anti-Roll**

**Wrench-Ready**

Model #	Description
48-22-9404	26 Pc 1/4" Drive SAE Ratchet & Socket Set with FOUR FLAT™ Sides
48-22-9408	28 Pc 3/8" Drive SAE Ratchet & Socket Set with FOUR FLAT™ Sides
48-22-9410	22 Pc 1/2" Drive SAE Ratchet & Socket Set with FOUR FLAT™ Sides
48-22-9504	28 Pc 1/4" Drive Metric Ratchet & Socket Set with FOUR FLAT™ Sides
48-22-9508	32 Pc 3/8" Drive Metric Ratchet & Socket Set with FOUR FLAT™ Sides
48-22-9510	28 Pc 1/2" Drive Metric Ratchet & Socket Set with FOUR FLAT™ Sides
48-22-9004	50 Pc 1/4" Drive Metric & SAE Ratchet & Socket Set with FOUR FLAT™ Sides
48-22-9008	56 Pc 3/8" Drive Metric & SAE Ratchet & Socket Set with FOUR FLAT™ Sides
48-22-9010	47 Pc 1/2" Drive Metric & SAE Ratchet & Socket Set with FOUR FLAT™ Sides

## RATCHETING COMBINATION WRENCHES

**BETTER ACCESS.  
LONGEST LIFE.**

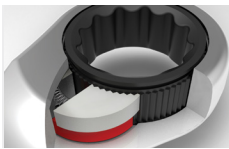
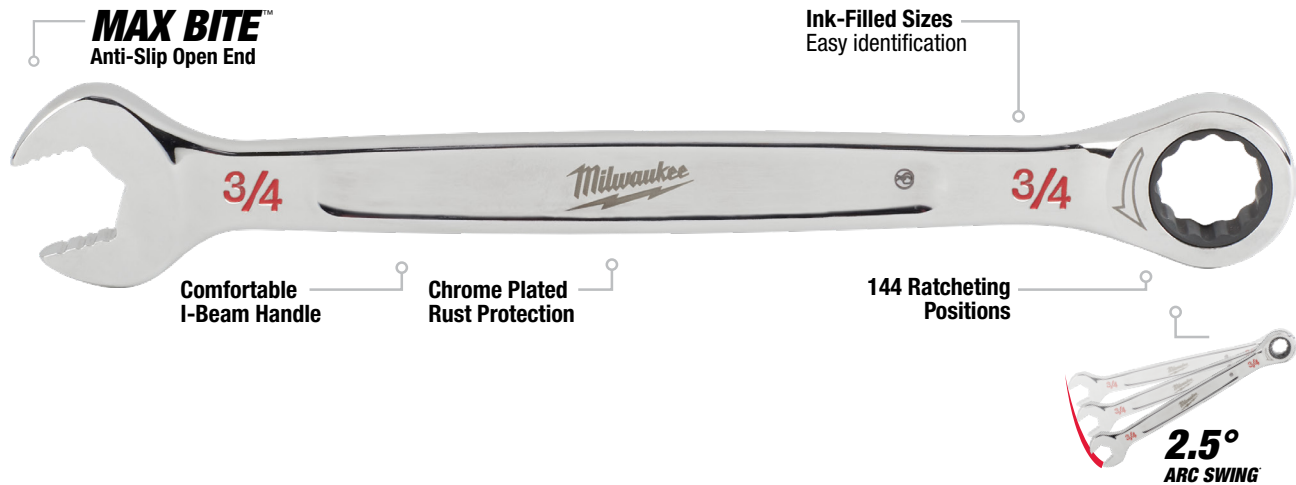

**Durable Double Stacked Pawls**

Model #	Description	Included Sizes
48-22-9406	7 Pc SAE Ratcheting Combination Wrench Set	3/8", 7/16", 1/2", 9/16", 5/8", 11/16", 3/4"
48-22-9506	7 Pc Metric Ratcheting Combination Wrench Set	8mm, 10mm, 12mm, 13mm, 14mm, 15mm, 17mm
48-22-9416	15 Pc SAE Ratcheting Combination Wrench Set	1/4", 9/32", 5/16", 11/32", 3/8", 7/16", 1/2", 9/16", 5/8", 11/16", 3/4", 13/16", 7/8", 15/16", 1"
48-22-9516	15 Pc Metric Ratcheting Combination Wrench Set	8mm, 9mm, 10mm, 11mm, 12mm, 13mm, 14mm, 15mm, 16mm, 17mm, 18mm, 19mm, 20mm, 21mm, 22mm

Model #	Description
45-96-9208	1/4" SAE Ratcheting Combination Wrench
45-96-9209	9/32" SAE Ratcheting Combination Wrench
45-96-9210	5/16" SAE Ratcheting Combo Wrench
45-96-9211	11/32" SAE Ratcheting Combination Wrench
45-96-9212	3/8" SAE Ratcheting Combination Wrench
45-96-9214	7/16" SAE Ratcheting Combination Wrench
45-96-9216	1/2" SAE Ratcheting Combination Wrench
45-96-9218	9/16" SAE Ratcheting Combination Wrench
45-96-9220	5/8" SAE Ratcheting Combination Wrench
45-96-9222	11/16" SAE Ratcheting Combination Wrench
45-96-9224	3/4" SAE Ratcheting Combination Wrench
45-96-9226	13/16" SAE Ratcheting Combination Wrench
45-96-9228	7/8" SAE Ratcheting Combination Wrench
45-96-9230	15/16" SAE Ratcheting Combo Wrench
45-96-9232	1" SAE Ratcheting Combination Wrench

Model #	Description
45-96-9308	8mm Metric Ratcheting Combination Wrench
45-96-9309	9mm Metric Ratcheting Combination Wrench
45-96-9310	10mm Metric Ratcheting Combination Wrench
45-96-9311	11mm Metric Ratcheting Combination Wrench
45-96-9312	12mm Metric Ratcheting Combination Wrench
45-96-9313	13mm Metric Ratcheting Combination Wrench
45-96-9314	14mm Metric Ratcheting Combination Wrench
45-96-9315	15mm Metric Ratcheting Combination Wrench
45-96-9316	16mm Metric Ratcheting Combination Wrench
45-96-9317	17mm Metric Ratcheting Combination Wrench
45-96-9318	18mm Metric Ratcheting Combination Wrench
45-96-9319	19mm Metric Ratcheting Combination Wrench
45-96-9320	20mm Metric Ratcheting Combination Wrench
45-96-9321	21mm Metric Ratcheting Combination Wrench
45-96-9322	22mm Metric Ratcheting Combination Wrench

# COMBINATION WRENCHES

## COMBINATION WRENCHES

UP TO  
**25% MORE TORQUE**



**Innovative Storage Solution**

Model #	Description	Included Sizes
48-22-9407	7 Pc SAE Combination Wrench Set	3/8", 7/16", 1/2", 9/16", 5/8", 11/16", 3/4"
48-22-9507	7 Pc Metric Combination Wrench Set	8mm, 10mm, 12mm, 13mm, 14mm, 15mm, 17mm
48-22-9415	15 Pc SAE Combination Wrench Set	1/4", 9/32", 5/16", 11/32", 3/8", 7/16", 1/2", 9/16", 5/8", 11/16", 3/4", 13/16", 7/8", 15/16", 1"
48-22-9515	15 Pc Metric Combination Wrench Set	8mm, 9mm, 10mm, 11mm, 12mm, 13mm, 14mm, 15mm, 16mm, 17mm, 18mm, 19mm, 20mm, 21mm, 22mm

Model #	Description
45-96-9408	1/4" SAE Combination Wrench
45-96-9409	9/32" SAE Combination Wrench
45-96-9410	5/16" SAE Combo Wrench
45-96-9411	11/32" SAE Combination Wrench
45-96-9412	3/8" SAE Combination Wrench
45-96-9414	7/16" SAE Combination Wrench
45-96-9416	1/2" SAE Combination Wrench
45-96-9418	9/16" SAE Combination Wrench
45-96-9420	5/8" SAE Combination Wrench
45-96-9422	11/16" SAE Combination Wrench
45-96-9424	3/4" SAE Combination Wrench
45-96-9426	13/16" SAE Combination Wrench
45-96-9428	7/8" SAE Combination Wrench
45-96-9430	15/16" SAE Combo Wrench
45-96-9432	1" SAE Combination Wrench

Model #	Description
45-96-9508	8mm Metric Combination Wrench
45-96-9509	9mm Metric Combination Wrench
45-96-9510	10mm Metric Combination Wrench
45-96-9511	11mm Metric Combination Wrench
45-96-9512	12mm Metric Combination Wrench
45-96-9513	13mm Metric Combination Wrench
45-96-9514	14mm Metric Combination Wrench
45-96-9515	15mm Metric Combination Wrench
45-96-9516	16mm Metric Combination Wrench
45-96-9517	17mm Metric Combination Wrench
45-96-9518	18mm Metric Combination Wrench
45-96-9519	19mm Metric Combination Wrench
45-96-9520	20mm Metric Combination Wrench
45-96-9521	21mm Metric Combination Wrench
45-96-9522	22mm Metric Combination Wrench

## SOCKETS WITH FOUR FLAT™ SIDES

# MOST VERSATILE SOCKETS. ANTI-ROLL, WRENCH-READY.



**SAE**   **METRIC**

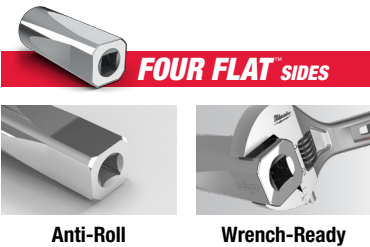

Model #	Description
45-34-9001	1/4" Drive 3/16" SAE Socket
45-34-9002	1/4" Drive 7/32" SAE Socket
45-34-9003	1/4" Drive 1/4" SAE Socket
45-34-9004	1/4" Drive 9/32" SAE Socket
45-34-9005	1/4" Drive 5/16" SAE Socket
45-34-9006	1/4" Drive 11/32" SAE Socket
45-34-9007	1/4" Drive 3/8" SAE Socket
45-34-9008	1/4" Drive 7/16" SAE Socket
45-34-9009	1/4" Drive 1/2" SAE Socket
45-34-9010	1/4" Drive 9/16" SAE Socket
45-34-9011	1/4" Drive 5/32" SAE Deep Socket
45-34-9012	1/4" Drive 3/16" SAE Deep Socket
45-34-9013	1/4" Drive 7/32" SAE Deep Socket
45-34-9014	1/4" Drive 1/4" SAE Deep Socket
45-34-9015	1/4" Drive 9/32" SAE Deep Socket
45-34-9016	1/4" Drive 5/16" SAE Deep Socket
45-34-9017	1/4" Drive 11/32" SAE Deep Socket
45-34-9018	1/4" Drive 3/8" SAE Deep Socket
45-34-9019	1/4" Drive 7/16" SAE Deep Socket
45-34-9020	1/4" Drive 1/2" SAE Deep Socket
45-34-9021	1/4" Drive 9/16" SAE Deep Socket
45-34-9060	3/8" Drive 1/4" SAE Socket
45-34-9061	3/8" Drive 5/16" SAE Socket
45-34-9062	3/8" Drive 3/8" SAE Socket
45-34-9063	3/8" Drive 7/16" SAE Socket
45-34-9064	3/8" Drive 1/2" SAE Socket
45-34-9065	3/8" Drive 9/16" SAE Socket
45-34-9066	3/8" Drive 5/8" SAE Socket
45-34-9067	3/8" Drive 11/16" SAE Socket
45-34-9068	3/8" Drive 3/4" SAE Socket
45-34-9069	3/8" Drive 13/16" SAE Socket
45-34-9070	3/8" Drive 7/8" SAE Socket
45-34-9071	3/8" Drive 15/16" SAE Socket
45-34-9072	3/8" Drive 1" SAE Socket
45-34-9073	3/8" Drive 1/4" SAE Deep Socket
45-34-3125	3/8" Drive 5/16" SAE Deep Socket

Model #	Description
45-34-3750	3/8" Drive 3/8" SAE Deep Socket
45-34-4375	3/8" Drive 7/16" SAE Deep Socket
45-35-5000	3/8" Drive 1/2" SAE Deep Socket
45-34-5625	3/8" Drive 9/16" SAE Deep Socket
45-34-6250	3/8" Drive 5/8" SAE Deep Socket
45-34-6875	3/8" Drive 11/16" SAE Deep Socket
45-34-7500	3/8" Drive 3/4" SAE Deep Socket
45-34-9074	3/8" Drive 13/16" SAE Deep Socket
45-34-9075	3/8" Drive 7/8" SAE Deep Socket
45-34-9100	1/2" Drive 1/2" SAE Socket
45-34-9101	1/2" Drive 9/16" SAE Socket
45-34-9102	1/2" Drive 5/8" SAE Socket
45-34-9103	1/2" Drive 11/16 SAE Socket
45-34-9104	1/2" Drive 3/4" SAE Socket
45-34-9105	1/2" Drive 13/16" SAE Socket
45-34-9106	1/2" Drive 7/8" SAE Socket
45-34-9107	1/2" Drive 15/16" SAE Socket
45-34-9108	1/2" Drive 1" SAE Socket
45-34-9109	1/2" Drive 1-1/16" SAE Socket
45-34-9110	1/2" Drive 1-1/8" SAE Socket
45-34-9126	1/2" Drive 1/2" SAE Deep Socket
45-34-9127	1/2" Drive 9/16" SAE Deep Socket
45-34-9128	1/2" Drive 5/8" SAE Deep Socket
45-34-9129	1/2" Drive 11/16" SAE Deep Socket
45-34-9130	1/2" Drive 3/4" SAE Deep Socket
45-34-9131	1/2" Drive 13/16" SAE Deep Socket
45-34-9132	1/2" Drive 7/8" SAE Deep Socket
45-34-9133	1/2" Drive 15/16" SAE Deep Socket
45-34-9085	3/8" Drive 15mm Metric Socket
45-34-9086	3/8" Drive 16mm Metric Socket
45-34-9087	3/8" Drive 17mm Metric Socket
45-34-9088	3/8" Drive 18mm Metric Socket
45-34-9089	3/8" Drive 19mm Metric Socket
45-34-9090	3/8" Drive 6mm Metric Deep Socket
45-34-9091	3/8" Drive 7mm Metric Deep Socket
45-34-9092	3/8" Drive 8mm Metric Deep Socket

Model #	Description
45-34-9093	3/8" Drive 9mm Metric Deep Socket
45-34-0010	3/8" Drive 10mm Metric Deep Socket
45-34-9094	3/8" Drive 11mm Metric Deep Socket
45-34-0012	3/8" Drive 12mm Metric Deep Socket
45-34-0013	3/8" Drive 13mm Metric Deep Socket
45-34-0014	3/8" Drive 14mm Metric Deep Socket
45-34-0015	3/8" Drive 15mm Metric Deep Socket
45-34-9095	3/8" Drive 16mm Metric Deep Socket
45-34-0117	3/8" Drive 17mm Metric Deep Socket
45-34-0118	3/8" Drive 18mm Metric Deep Socket
45-34-0119	3/8" Drive 19mm Metric Deep Socket
45-34-9111	1/2" Drive 10mm Metric Socket
45-34-9112	1/2" Drive 11mm Metric Socket
45-34-9113	1/2" Drive 12mm Metric Socket
45-34-9114	1/2" Drive 13mm Metric Socket
45-34-9115	1/2" Drive 14mm Metric Socket
45-34-9116	1/2" Drive 15mm Metric Socket
45-34-9117	1/2" Drive 16mm Metric Socket
45-34-9118	1/2" Drive 17mm Metric Socket
45-34-9119	1/2" Drive 18mm Metric Socket
45-34-9120	1/2" Drive 19mm Metric Socket
45-34-9121	1/2" Drive 20mm Metric Socket
45-34-9122	1/2" Drive 21mm Metric Socket
45-34-9123	1/2" Drive 22mm Metric Socket
45-34-9124	1/2" Drive 23mm Metric Socket
45-34-9125	1/2" Drive 24mm Metric Socket
45-34-9134	1/2" Drive 10mm Metric Deep Socket
45-34-9135	1/2" Drive 11mm Metric Deep Socket
45-34-9136	1/2" Drive 12mm Metric Deep Socket
45-34-9137	1/2" Drive 13mm Metric Deep Socket
45-34-9138	1/2" Drive 14mm Metric Deep Socket
45-34-9139	1/2" Drive 15mm Metric Deep Socket
45-34-9140	1/2" Drive 16mm Metric Deep Socket
45-34-9141	1/2" Drive 17mm Metric Deep Socket
45-34-9142	1/2" Drive 18mm Metric Deep Socket
45-34-9143	1/2" Drive 19mm Metric Deep Socket



# DRIVE RATCHETS, BREAKER BARS & SOCKET ACCESSORIES

## RATCHETS

### BETTER ACCESS



**Slim Design**  
Access tight places

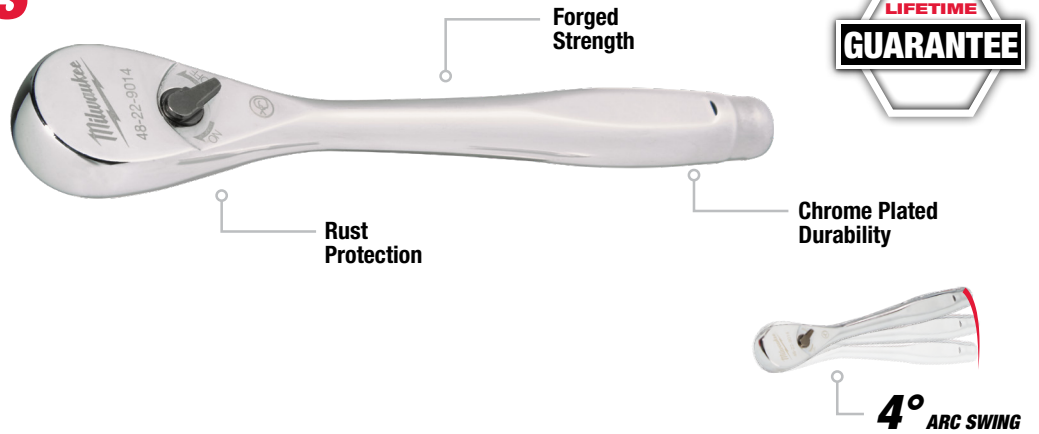

Model #	Description
48-22-9014	1/4" Drive Ratchet
48-22-9038	3/8" Drive Ratchet

Model #	Description
48-22-9012	1/2" Drive Ratchet

## BREAKER BARS

### BETTER LEVERAGE

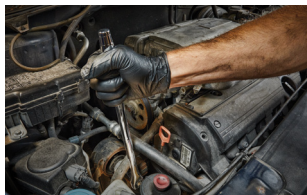

**180° Pivoting Head**

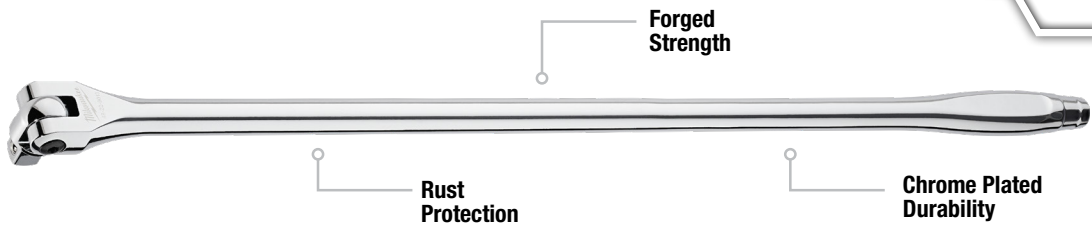

Model #	Description
48-22-9011	1/2" Drive 15" Breaker Bar

Model #	Description
48-22-9013	1/2" Drive 24" Breaker Bar

## SOCKET ACCESSORIES



**Extended Reach**

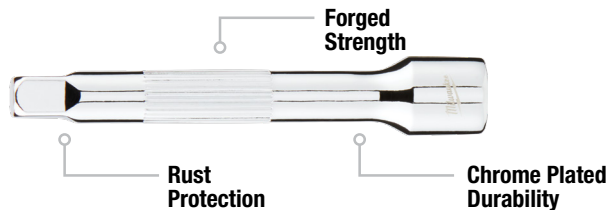

Model #	Description
43-24-9100	1/4" Drive 3" Extension
43-24-9101	1/4" Drive 6" Extension
42-04-9102	1/4" Drive Universal Joint
43-24-9102	3/8" Drive 3" Extension

Model #	Description
43-24-0006	3/8" Drive 6" Extension
42-04-9103	3/8" Drive Universal Joint
43-24-9103	1/2" Drive 3" Extension
43-24-9104	1/2" Drive 5" Extension

# HOOK AND PICKS, PRY BARS AND MULTI-BIT DRIVERS

## HOOK AND PICK SET

UP TO  
**50% MORE DURABLE**

**ALL-METAL CORE**

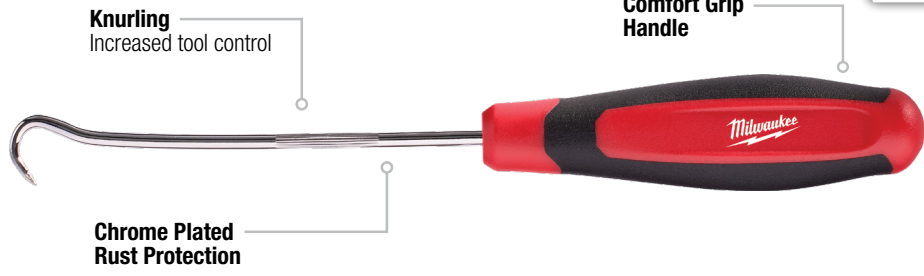

Easy Access Storage Tray

Model #	Description	Includes
48-22-9215	4 Pc Hook and Pick Set	Straight Pick, Offset Hook, Hook, 90° Hook

## PRY BARS

UP TO  
**40% MORE PRYING STRENGTH**

**I-BEAM DESIGN**

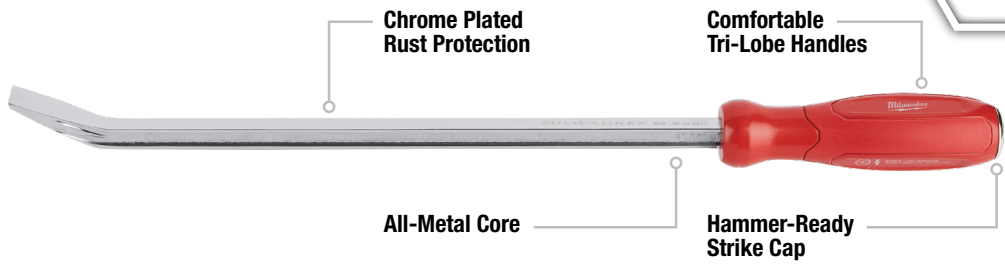

Easy Access Storage Tray

Model #	Description	Included Lengths
48-22-9214	4 Pc Pry Bar Set	8", 12", 18", 24"

## 11IN1 MULTI-BIT DRIVERS

**11IN1**

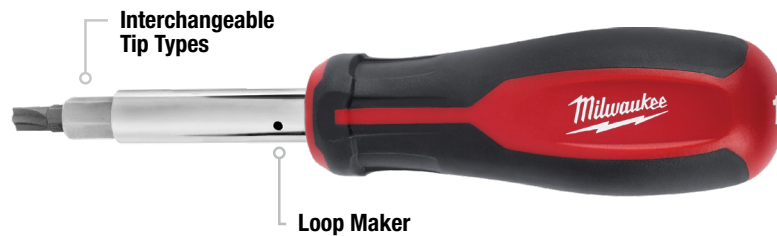

Comfortable Tri-Lobe Handle

Model #	Description	Nut Drivers	Bit Types
48-22-2760	11in1 Multi-Bit Driver w/ ECX™	1/4", 5/16", 3/8"	P#1, P#2, SL 3/16", SL 1/4", SQ#1, SQ#2, ECX™#1, ECX™#2
48-22-2761	11in1 Multi-Bit Driver w/ TORX®	1/4", 5/16", 3/8"	P#1, P#2, SL 3/16", SL 1/4", SQ#1, SQ#2, T10, T15

## 13IN1 CUSHION-GRIP SCREWDRIVERS

### 13IN1



ECX™ Bit



Schrader® Valve Core Remover



Loop Maker



Wrench-Ready Bolster  
Increased torque



Cushion Grip  
Anti-Peel design

Model #	Description	Nut Drivers	Bit Types
48-22-2880	13in1 Cushion-Grip Screwdriver with ECX™ Bit	1/4", 5/16", 3/8", 1/2"	P#1, P#2, SL 3/16", SL1/4", SQ#1, SQ#2, ECX™#1, ECX™#2
48-22-2881	13in1 Cushion-Grip Screwdriver with Schrader® Bit	1/4", 5/16", 3/8", 1/2"	P#1, P#2, SL 3/16", SL1/4", SQ#1, SQ#2, Std Schrader®, Large Schrader®

## SCREWDRIVERS

### HIGH-LEVERAGE HANDLE. MAGNETIC TIP.



Also Available:



Bottle Opener  
48-22-2700



Comfortable Tri-Lobe Handle

Model #	Description	Bit Types
48-22-2702	2 Pc Demolition Screwdriver Set	P#2, SL 5/16"
48-22-2706	6 Pc Screwdriver Set	P#1, P#2, SL 3/16", SL 1/4", SL 5/16"
48-22-2708	8 Pc Screwdriver Set w/ ECX™	P#1, P#2, SL 3/16", SL 1/4", SL 5/16", ECX™#1, ECX™#2
48-22-2710	10 Pc Screwdriver Set	P#1, P#2, SL 3/16", SL 1/4", SL 5/16", SQ#1, SQ#2
48-22-2718	8 Pc Screwdriver Set w/ Square	P#1, P#2, SL 3/16", SL 1/4", SL 5/16", SQ#1, SQ#2
48-22-2700	Bottle Opener	

## CUSHION-GRIP SCREWDRIVERS

### MOST DURABLE HANDLE. PRECISION TIP.



Anti-Peel Design  
Cushion Grips

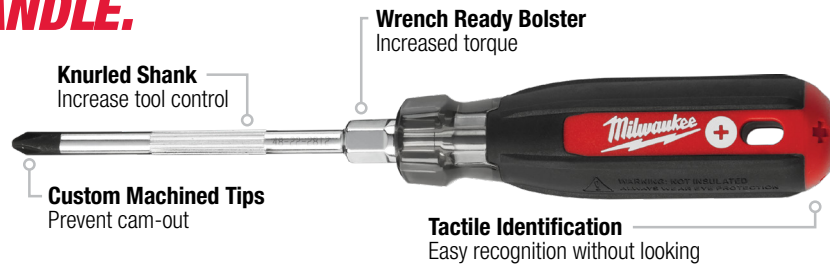

Knurled Shank  
Increase tool control

Custom Machined Tips  
Prevent cam-out

Wrench Ready Bolster  
Increased torque

Tactile Identification  
Easy recognition without looking

Model #	Description
48-22-2811	#1 Phillips (3")
48-22-2812	#2 Phillips (4")
48-22-2813	#3 Phillips (6")
48-22-2814	#2 Phillips (10")
48-22-2815	#2 Phillips (6") Cushion-Grip Demolition Screwdriver

Model #	Description
48-22-2821	1/4" Slotted (4")
48-22-2822	5/16" Slotted (6")
48-22-2824	3/8" Slotted (8")
48-22-2831	3/16" Cabinet (3")
48-22-2832	3/16" Cabinet (6")
48-22-2833	3/16" Cabinet (8")

Model #	Description
48-22-2834	1/4" Cabinet (10")
48-22-2841	#1 ECX™ (4")
48-22-2842	#2 ECX™ (4")
48-22-2851	#1 Square (3")
48-22-2852	#2 Square (4")
48-22-2853	#3 Square (6")

Model #	Description	Bit Types
48-22-2884	4 Pc Cushion-Grip Screwdriver Set	P#2, SL 1/4", SL 5/16", SL 6"
48-22-2885	5 Pc Cushion-Grip Screwdriver Set	P#2, SL 1/4", SL 5/16", SL 6"
48-22-2886	6 Pc Cushion-Grip Screwdriver Set	P#2, P#3, SL 1/4", SL 3/16", SL 5/16"

## DEMO DRIVER

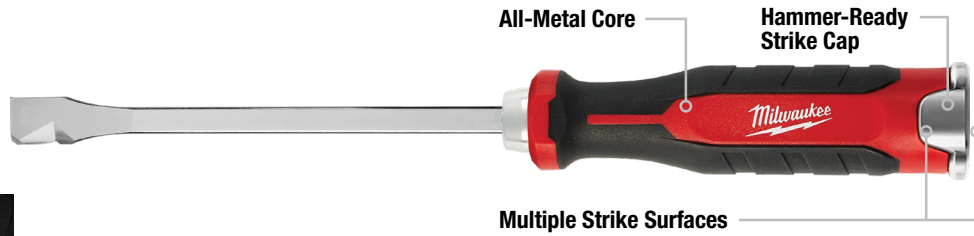

**Aggressive Duct Piercing Tip**

Model #	Description
48-22-2860	Demo Driver
48-22-2823	Slotted 5/16" 6" Cushion-Grip Demolition Screwdriver
48-22-2825	Slotted 3/8" 8" Cushion-Grip Demolition Screwdriver

## 1000V INSULATED SCREWDRIVERS

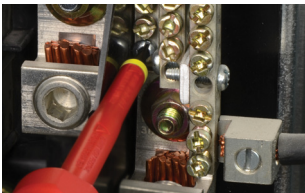
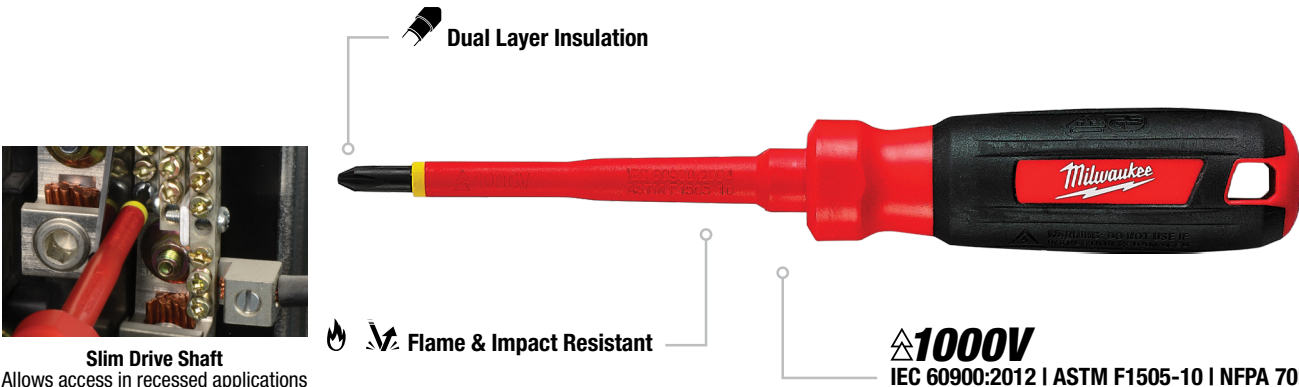

**Slim Drive Shaft**  
Allows access in recessed applications

Model #	Description
48-22-2211	#1 Phillips (3")
48-22-2212	#2 Phillips (4")
48-22-2213	#3 Phillips (6")
48-22-2221	1/4" Slotted (6")
48-22-2222	5/16" Slotted (7")
48-22-2223	3/8" Slotted (8")
48-22-2224	3/8" Slotted (10")
48-22-2231	3/16" Cabinet (4")

Model #	Description
48-22-2232	3/16" Cabinet (6")
48-22-2233	3/16" Cabinet (8")
48-22-2241	#1 ECX™ (4")
48-22-2242	#2 ECX™ (4")
48-22-2251	#1 Square (3")
48-22-2252	#2 Square (4")
48-22-2253	#3 Square (6")

Model #	Description	Bit Types, Carrying Case
48-22-2202	3 Pc 1000V Insulated Screwdriver Set	P#2, SL 1/4", ECX™#1
48-22-2204	4 Pc 1000V Insulated Screwdriver Set w/ Case	P#1, P#2, SL 1/4", SL 3/8", Extra Capacity Roll Up Pouch
48-22-2205	4 Pc 1000V Insulated Screwdriver Set w/ Case	SL 1/4", SL 3/8", SQ#1, SQ#2, Extra Capacity Roll Up Pouch
48-22-2210	10 Pc 1000V Insulated Screwdriver Set w/ Case	P#1, P#2, P#3, SL 1/4", SL 5/16", SL 3/8", SQ#1, SQ#2, SQ#3, ECX™#1, EVA Foam Fitted Case
48-22-2203	3 Pc 1000V Insulated Screwdriver Set	#1 ECX™ (4"), #2 Phillips (4"), 1/4" Slotted (6")

## PRECISION SCREWDRIVERS

UP TO **4X STRONGER**

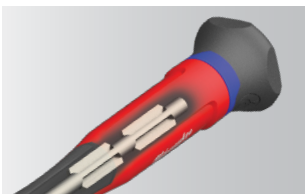
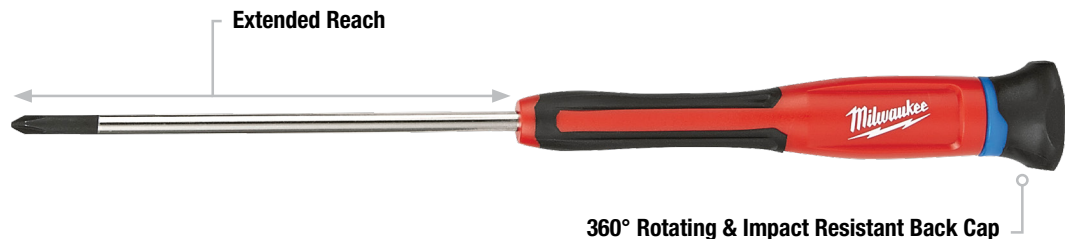

**All-Metal Core**

Model #	Description	Bit Types
48-22-2604	4 Pc Precision Screwdriver Set	P#1, SL 1/16", SL 3/32", SL 1/8"
48-22-2606	6 Pc Precision Screwdriver Set w/ Case	P#1, P#2, SL 1/16", SL 3/32", SL 1/8", SL 5/32"
48-22-2610	6 Pc TORX® Precision Screwdriver Set w/ Case	T6, T7, T8, T9, T10, T15



## HOLLOWCORE™ MAGNETIC NUT DRIVERS

UNLIMITED DEPTH

FITS **4X** MORE FASTENERS

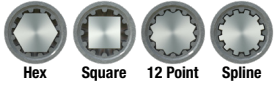

**SAE** **METRIC**

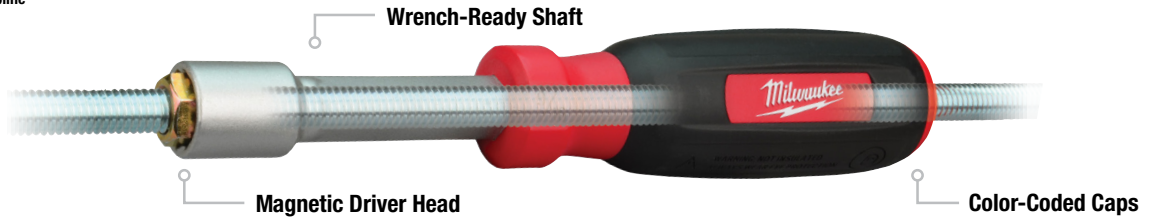

Model #	Description	Sizes
48-22-2502	2 Pc HOLLOWCORE™ Magnetic Nut Driver Set	1/4", 5/16"
48-22-2507	7 Pc HOLLOWCORE™ SAE Magnetic Nut Driver Set	1/4", 5/16", 11/32", 3/8", 7/16", 1/2", 9/16"
48-22-2517	7 Pc HOLLOWCORE™ Metric Magnetic Nut Driver Set	5mm, 5.5mm, 6mm, 7mm, 8mm, 10mm, 13mm

Model #	Description
48-22-2520	3/16" Magnetic Nut Driver
48-22-2521	1/4" HOLLOWCORE™ Magnetic Nut Driver
48-22-2522	5/16" HOLLOWCORE™ Magnetic Nut Driver
48-22-2523	11/32" HOLLOWCORE™ Magnetic Nut Driver
48-22-2524	3/8" HOLLOWCORE™ Magnetic Nut Driver

Model #	Description
48-22-2525	7/16" HOLLOWCORE™ Magnetic Nut Driver
48-22-2526	1/2" HOLLOWCORE™ Magnetic Nut Driver
48-22-2527	9/16" HOLLOWCORE™ Magnetic Nut Driver
48-22-2531	5mm HOLLOWCORE™ Magnetic Nut Driver
48-22-2532	5.5mm HOLLOWCORE™ Magnetic Nut Driver

Model #	Description
48-22-2533	6mm HOLLOWCORE™ Magnetic Nut Driver
48-22-2534	7mm HOLLOWCORE™ Magnetic Nut Driver
48-22-2535	8mm HOLLOWCORE™ Magnetic Nut Driver
48-22-2536	10mm HOLLOWCORE™ Magnetic Nut Driver
48-22-2537	13mm HOLLOWCORE™ Magnetic Nut Driver

## HOLLOW SHAFT NUT DRIVERS

FITS **4X** MORE FASTENERS

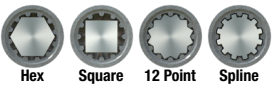

**SAE** **METRIC**

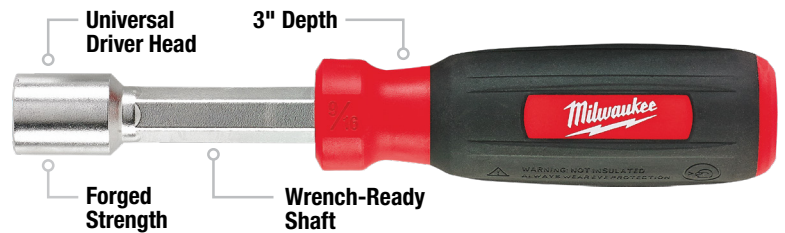

Model #	Description	Sizes
48-22-2402	2 Pc SAE Hollow Shaft Nut Driver Set	1/4", 5/16"
48-22-2404	4 Pc SAE Hollow Shaft Nut Driver Set	1/4", 5/16", 7/16", 9/16"
48-22-2407	7 Pc SAE Hollow Shaft Nut Driver Set	1/4", 5/16", 11/32", 3/8", 7/16", 1/2", 9/16"
48-22-2417	7 Pc Metric Hollow Shaft Nut Driver Set	5mm, 5.5mm, 6mm, 7mm, 8mm, 10mm, 13mm

Model #	Description
48-22-2420	3/16" Hollow Shaft Nut Driver
48-22-2421	1/4" Hollow Shaft Nut Driver
48-22-2422	5/16" Hollow Shaft Nut Driver
48-22-2423	11/32" Hollow Shaft Nut Driver
48-22-2424	3/8" Hollow Shaft Nut Driver

Model #	Description
48-22-2425	7/16" Hollow Shaft Nut Driver
48-22-2426	1/2" Hollow Shaft Nut Driver
48-22-2427	9/16" Hollow Shaft Nut Driver
48-22-2431	5mm Hollow Shaft Nut Driver
48-22-2432	5.5mm Hollow Shaft Nut Driver

Model #	Description
48-22-2433	6mm Hollow Shaft Nut Driver
48-22-2434	7mm Hollow Shaft Nut Driver
48-22-2435	8mm Hollow Shaft Nut Driver
48-22-2436	10mm Hollow Shaft Nut Driver
48-22-2437	13mm Hollow Shaft Nut Driver

## FRAMING HAMMERS

UP TO  
**10x VIBRATION REDUCTION**  
SHOCKSHIELD™ GRIP

Available in



Smooth Face

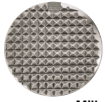

Milled Face

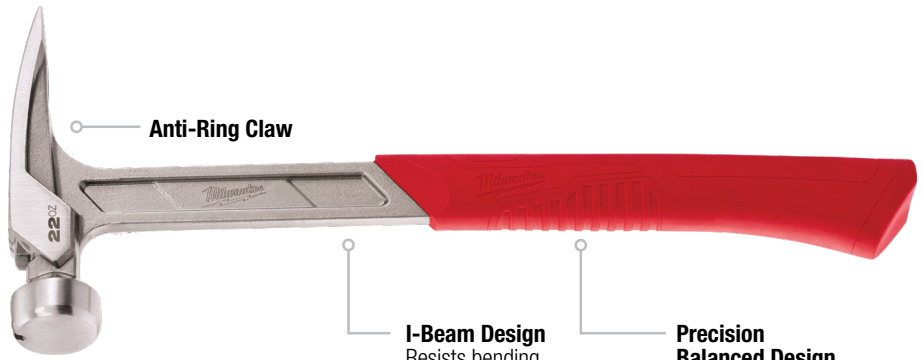

Magnetic Nail Set

Model #	Description
48-22-9016	17oz Milled Face Hammer
48-22-9017	17oz Smooth Face Hammer
48-22-9022	22oz Milled Face Hammer

Model #	Description
48-22-9023	22oz Smooth Face Hammer
48-22-9080	20oz Curved Claw Hammer

## POLY FIBERGLASS HAMMER

**MOST DURABLE FIBERGLASS HANDLE**

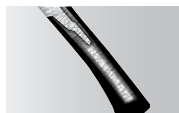

Reinforced Fiberglass Handle

Model #	Description
48-22-9316	19oz Smooth Face Poly/Fiberglass Hammer

## HICKORY HAMMERS

**BEST DRIVING PERFORMANCE**



Magnetic Nail Set

Model #	Description
48-22-9419	19oz Hickory Hammer – Milled Face
48-22-9419	19oz Hickory Hammer – Smooth Face

## HARDLINE™ FIXED BLADE KNIVES

**ULTIMATE DURABILITY™**  
**AUS-8 STEEL™**



Multi-Position Sheath



Model #	Description
48-22-1928	5" HARDLINE™ Fixed Blade Knife
48-22-1928B	5" HARDLINE™ Fixed Blade Knife

# LINEMAN, FIXED BLADE, & POCKET KNIVES

## LINEMAN'S HAWKBILL KNIVES

**STAYS SHARPER LONGER**



Universal Hot Stick Compatible



**STICKWORK™ 3IN1 RING**

- Shotgun Hot Stick Compatible
- Universal Hot Stick Compatible
- Hang Ring



Also Available:  
Hawkbill Fixed Blade Knife  
48-22-1925

Model #	Description
48-22-1923	Lineman's Hawkbill Knife with STICKWORK™ 3in1 Ring
48-22-1924	Lineman's Blunt Tip Hawkbill Knife with STICKWORK™ 3in1 Ring
48-22-1925	Hawkbill Fixed Blade Knife

## LINEMAN'S UNDERGROUND KNIFE

**STAYS SHARPER LONGER**



Blade Cover Storage



Model #	Description
48-22-1929	Lineman's Underground Knife

## FIXED BLADE KNIFE

**STAYS SHARPER LONGER**



Durable Sheath



Model #	Description
48-22-1926	4" Tradesman Fixed Blade Knife

## HARDLINE™ POCKET KNIVES

**EXTREME WEAR RESISTANCE™**

**D2 STEEL™**



Drop Point Smooth Blade



Model #	Description
48-22-1994	HARDLINE™ 3" Smooth Blade Pocket Knife
48-22-1997	HARDLINE™ 2-1/2" Smooth Blade Pocket Knife

Model #	Description
48-22-1998	HARDLINE™ 3" Serrated Blade Pocket Knife
48-22-1999	HARDLINE™ 3-1/2" Smooth Blade Pocket Knife

## FASTBACK™ 5in1 FOLDING KNIFE

**PRESS AND FLIP™**



Bottle Opener

Model #	Description
48-22-1540	FASTBACK™ 5in1 Folding Knife

## FASTBACK™ HAWKBILL FOLDING KNIVES

**PRESS AND FLIP™**

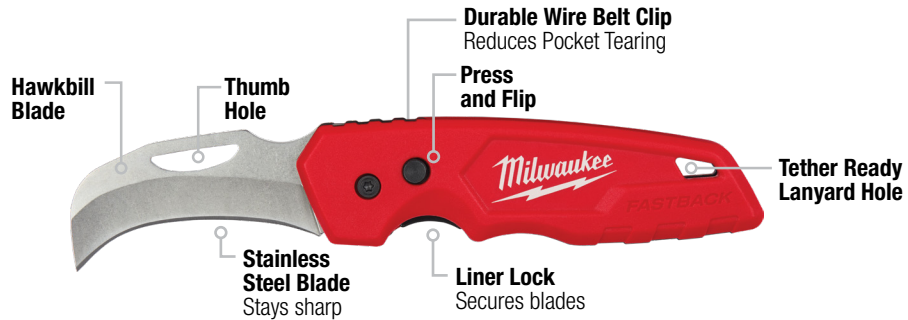

Ideal for Stripping Cable

Model #	Description
48-22-1525	FASTBACK™ Hawkbill Folding Knife
48-22-1526	FASTBACK™ Blunt Tip Hawkbill Folding Knife

## FASTBACK™ FOLDING KNIVES

**PRESS AND FLIP™**



Also Available:



FASTBACK™ Camo Folding Knife  
48-22-1524

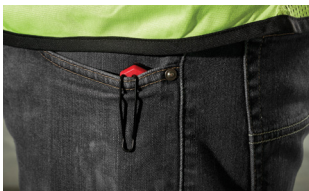

Durable Wire Belt Clip  
Reduces pocket tearing

Model #	Description
48-22-1520	FASTBACK™ Folding Knife
48-22-1525	FASTBACK™ Hawkbill Folding Flip Knife
48-22-1524	FASTBACK™ Camo Folding Knife



# FASTBACK™ POCKET & FOLDING KNIVES

## FASTBACK™ SPRING ASSISTED POCKET KNIVES

**Spring Assisted**



Partially Serrated



Also Available:



**FASTBACK™ Camo Spring Assisted Knife**  
48-22-1996

Model #	Description
48-22-1530	FASTBACK™ Spring Assisted Knife
48-22-1535	FASTBACK™ Camo Spring Assisted Knife

## LOCKBACK POCKET KNIFE



Lockback  
Strong Secure Hold



Model #	Description
48-22-1940	Lockback Pocket Knife

## FASTBACK™ COMPACT FOLDING KNIFE

**PRESS AND FLIP**



Blade Holder Designed for Scoring

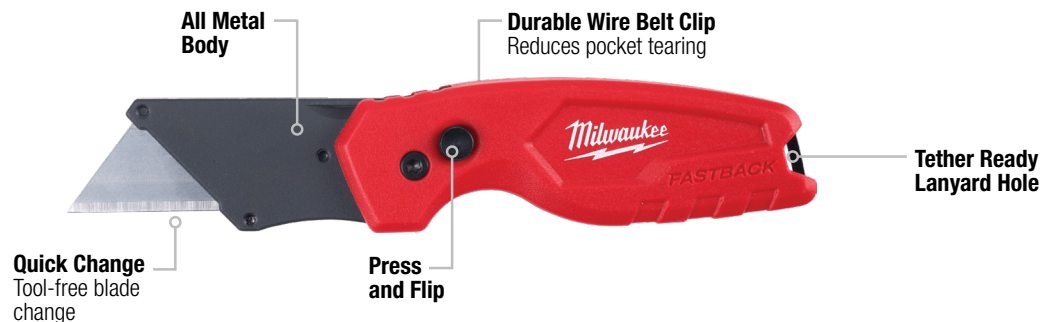

Model #	Description
48-22-1500	FASTBACK™ Compact Folding Utility Knife

## FASTBACK™ UTILITY KNIVES

### PRESS AND FLIP™

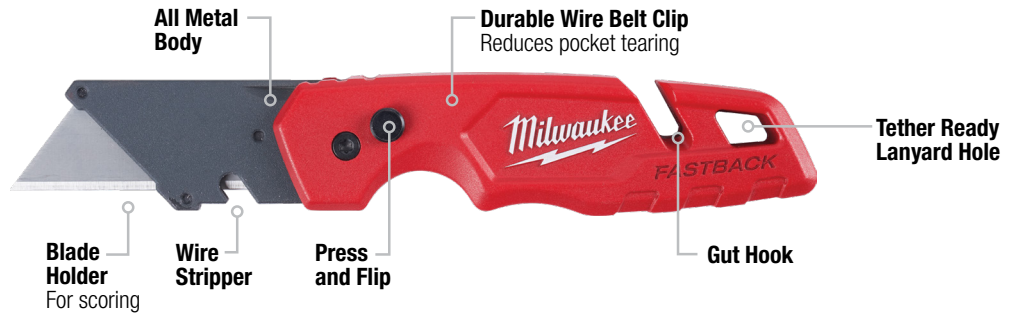

Wire Stripper

Model #	Description
48-22-1501	FASTBACK™ Folding Utility Knife
48-22-1502	FASTBACK™ Folding Utility Knife with Blade Storage
48-22-1503	FASTBACK™ Folding Utility Knife & FASTBACK™ Compact Knife Set

Model #	Description
48-22-1504	FASTBACK™ Folding Utility Knife with Blade Storage and 50 Pc General Blades
48-22-1901	FASTBACK™ Folding Utility Knife

## SIDE SLIDING UTILITY KNIFE

### MAXIMUM DEPTH CONTROL



Holds up to 5 Blades

Model #	Description
48-22-1510	Side Sliding Utility Knife

## FIXED BLADE UTILITY KNIFE

### FIXED BLADE



Overmold Grip

Model #	Description
48-22-1513	Fixed Blade Utility Knife

## GENERAL PURPOSE

LASTS **5X LONGER**



General Purpose



## HOOK

UP TO **2X STRONGER**



Ideal for Roofing



## DRYWALL

UP TO **2X SHARPER**



Ideal for Drywall



## CARTON

LASTS **5X LONGER**



Ideal for Cartons



Description	5 Pc	15 Pc (Case Included)	50 Pc (Dispenser Included)	75 Pc (Dispenser Included)	100 Pc (Dispenser Included)
General Purpose Utility Blades	48-22-1905	–	48-22-1950	48-22-1975	48-22-1900
Hook Utility Blades	48-22-1932	–	48-22-1952	–	–
Drywall Utility Blades	48-22-1933	–	48-22-1953	–	–
Carton Utility Blades	48-22-1934	–	48-22-1954	–	–
15 Pc Assorted Utility Blade Set	–	48-22-1930 (10) General Purpose, (2) Hook, (3) Carton	–	–	–

## SELF RETRACTING UTILITY KNIFE

## SAFETY CUTTER

UP TO **5X LONGER LIFE**



2 Blade Positions

Model #	Description
48-22-1512	Self Retracting Utility Knife

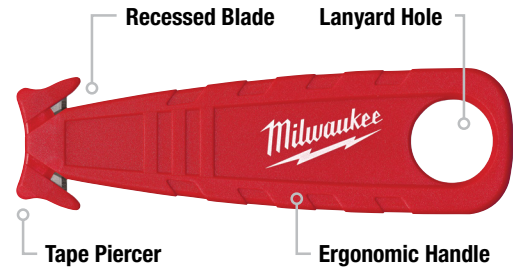

Model #	Description
48-22-1916	Safety Cutter

## PRECISION SNAP-OFF KNIVES

**METAL LOCK**

UP TO **10X LONGER LIFE**

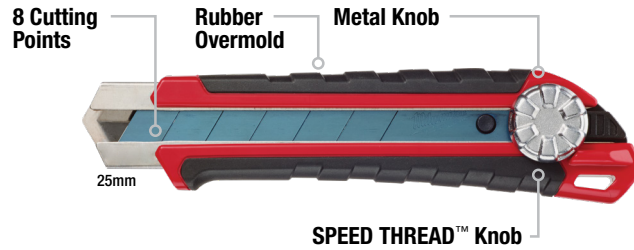

Model #	Description
48-22-1960	9mm (A) Precision Snap-Off Knife
48-22-1961	18mm (L) Precision Snap-Off Knife w/ Metal Lock

Model #	Description
48-22-1962	25mm (H) Precision Snap-Off Knife w/ Metal Lock



Blade Snap Off

Description	3 Pc	10 Pc
9mm (A) Precision Snap-Off Replacement Blades	48-22-9309	48-22-9109
18mm (L) Precision Snap-Off Replacement Blades	48-22-9318	48-22-9118
25mm (H) Precision Snap-Off Replacement Blades	48-22-9325	48-22-9125

## GENERAL PURPOSE SNAP-OFF KNIVES

**FASTER BLADE ADJUSTMENT**

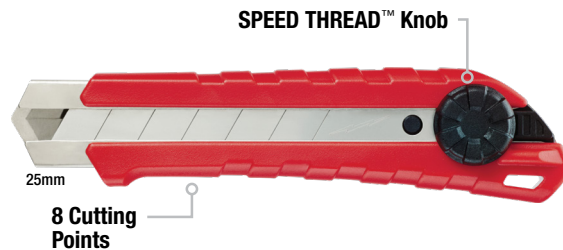

Model #	Description
48-22-1963	9mm (A) General Purpose Snap-Off Knife
48-22-1964	18mm (L) General Purpose Snap-Off Knife

Model #	Description
48-22-1965	25mm (H) General Purpose Snap-Off Knife



Blade Snap Off

Description	3 Pc	10 Pc
9mm (A) General Purpose Snap-Off Replacement Blades	48-22-1309	48-22-1109
18mm (L) General Purpose Snap-Off Replacement Blades	48-22-1318	48-22-1118
25mm (H) General Purpose Snap-Off Replacement Blades	48-22-1325	48-22-1125



## INSULATION KNIVES

### STAYS SHARPER LONGER

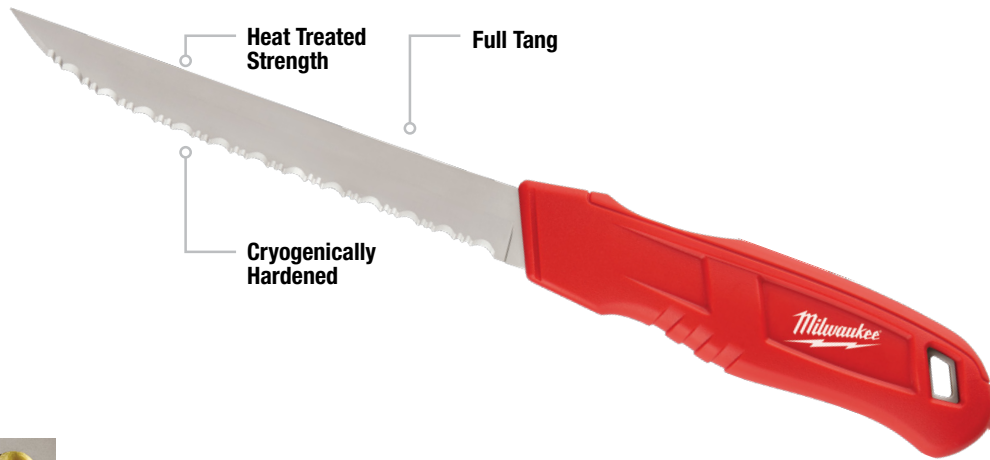

**Rounded Handle**  
Smoothing Applications

Model #	Description
48-22-1921	Insulation Knife (Smooth)
48-22-1922	Insulation Knife (Serrated)

## DUCT KNIFE

### STAYS SHARPER LONGER

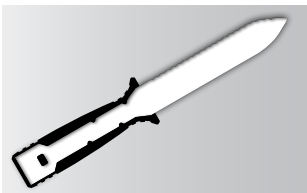
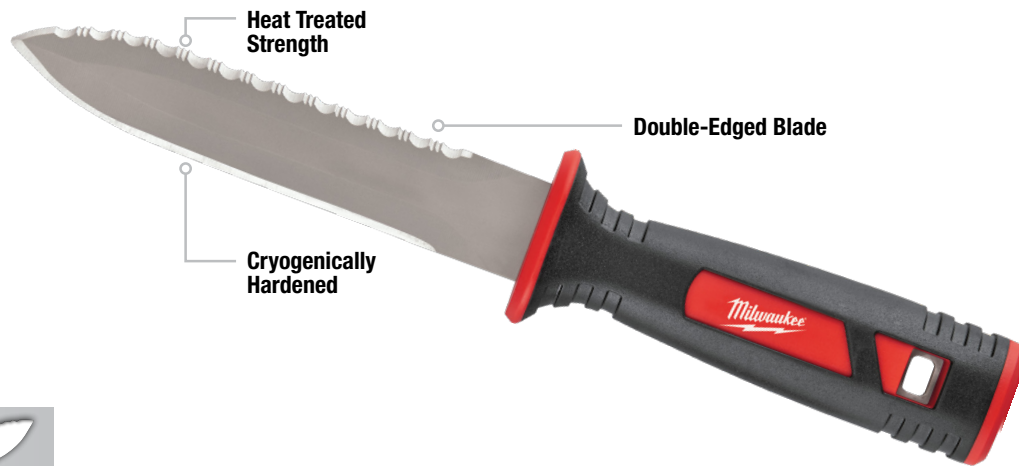

**Full Tang**

Model #	Description
48-22-1920	Duct Knife

## AVIATION SNIPS

UP TO  
**10X MORE CUTS**  
FORGED BLADES



**Flush Bolt Design**  
Won't hang up on material

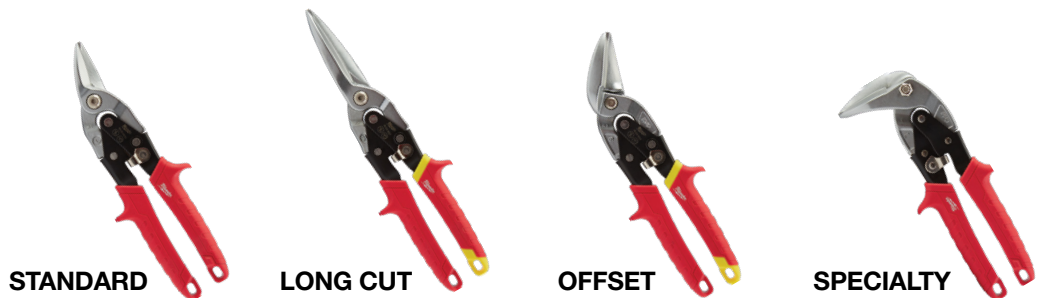

Model #	Description	Cold Rolled Steel	Stainless Steel
48-22-4530	Straight Cutting Standard Snips	18ga	22ga
48-22-4510	Left Cutting Standard Snips	18ga	22ga
48-22-4520	Right Cutting Standard Snips	18ga	22ga
48-22-4533	3 Pc Standard Snips Set	18ga	22ga
48-22-4532	Straight Cutting Offset Snips	18ga	22ga
48-22-4512	Left Cutting Offset Snips	18ga	22ga
48-22-4522	Right Cutting Offset Snips	18ga	22ga

Model #	Description	Cold Rolled Steel	Stainless Steel
48-22-4523	2 Pc Offset Snips Set	18ga	22ga
48-22-4537	Long Cut Straight Cutting Snips	20ga	22ga
48-22-4538	Long Cut Offset Snips	20ga	22ga
48-22-4500	Bulldog Snips	16ga	18ga
48-22-4511	Left Cutting Right Angle Snips	24ga	28ga
48-22-4521	Right Cutting Right Angle Snips	24ga	28ga

## OFFSET COMPOUND TINNER

### TOUGH CUTS

2X FORCE, LESS EFFORT

**BOLT LOCK** 



45° Offset Cut clearance

Model #	Description
48-22-4005	Offset Compound Tinner

## CLASSIC TINNERS

### BLADES WILL NOT LOOSEN

**BOLT LOCK** 



40% Larger Handle Loops

Model #	Description
48-22-4003	10" Classic Tinner
48-22-4002	12" Classic Tinner
48-22-4001	16" Bulldog Tinner

## DUCKBILL TINNER

### BLADES WILL NOT LOOSEN

**BOLT LOCK** 



40% Larger Handle Loops

Model #	Description
48-22-4004	10" Duckbill Tinner

## LIGHTWEIGHT TINNER

### STRAIGHTER, CLEANER CUTS

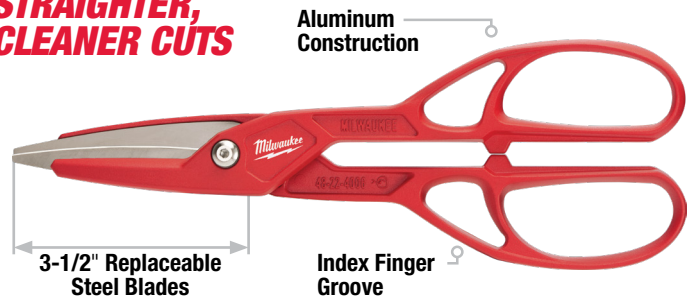

40% Larger Handle Loops

Model #	Description
48-22-4006	13" Lightweight Tinner
48-22-4007	Lightweight Tinner Replacement Blades

## JOBSITE SCISSORS

**ALL-METAL  
HANDLES**  
UP TO 10X LONGER LIFE



Ruler Marking on Blade

60° Offset Design

**Bolt Lock**  
Blades will not loosen



Index Finger Groove

Model #	Description
48-22-4040	Offset Jobsite Scissors (Serrated)

Model #	Description
48-22-4041	Straight Jobsite Scissors (Smooth)

## ADAPTABLE BOLT CUTTERS w/ POWERMOVE™ EXTENDABLE ARMS

**MORE CUTS.  
MAXIMUM VERSATILITY.**



Forged Steel Blades & Custom Heat Treated  
Maximum durability

Comfort Grip

Lanyard Hole

**Bolt Lock**  
Lasts longer, stays tight



**POWERMOVE™  
Extendable Arms**

Model #	Description	Max Capacity	
		Soft/Medium Materials (up to 31 HRC)	Hard Materials (up to 48 HRC)
48-22-4114	14" Adaptable Bolt Cutter	5/16"	3/16"
48-22-4124	24" Adaptable Bolt Cutter	7/16"	5/16"



# BOLT CUTTERS & HACKSAWS

## BOLT CUTTERS

**MORE CUTS.  
LONGER LIFE.**



**Forged Steel Blades & Custom Heat Treated**  
Maximum durability

Model #	Description	Max Capacity	
		Soft/Medium Materials (up to 31 HRC)	Hard Materials (up to 48 HRC)
48-22-4014	14" Bolt Cutter	5/16"	3/16"
48-22-4018	18" Bolt Cutter	3/8"	1/4"
48-22-4024	24" Bolt Cutter	7/16"	5/16"
48-22-4031	30" Bolt Cutter	1/2"	3/8"

## HIGH-TENSION HACKSAW

**MOST DURABLE.  
HIGHEST TENSION.**

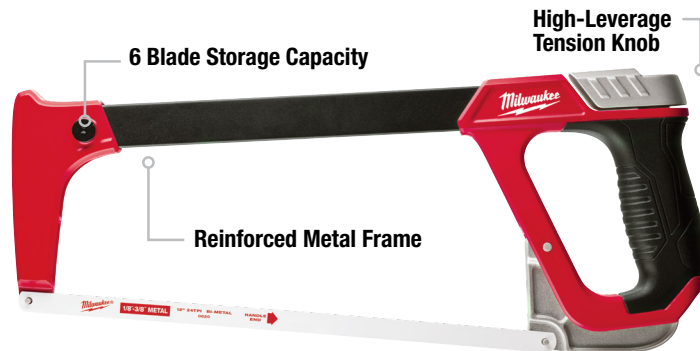

**45° Angle Blade Position**

Model #	Description
48-22-0050	10 Pc 12" High-Tension Hacksaw
48-43-0600	10 Pc 12" 14TPI Hacksaw Blade
48-43-0610	10 Pc 12" 18TPI Hacksaw Blade

Model #	Description
48-43-0620	10 Pc 12" 24TPI Hacksaw Blade
48-43-0630	10 Pc 12" 32TPI Hacksaw Blade

## COMPACT HACKSAW

**UP TO 10X FASTER BLADE CHANGE**



**Compact Design**



Model #	Description
48-22-0012	Compact Hacksaw

**RASPING JAB SAW**

UP TO **2X FASTER PLUNGE CUTS**



Piercing Tip

Model #	Description
48-22-0304	Rasping Jab Saw

**FOLDING JAB SAW**

UP TO **10X FASTER BLADE CHANGE**



Folding Blade

Model #	Description
48-22-0305	Folding Jab Saw

**PVC/ABS SAWS**

**FAST CUTS THROUGH PVC**



Metal Core

Model #	Description
48-22-0212	12" PVC/ABS Saw
48-22-0222	12" PVC/ABS Saw Replacement Blade
48-22-0223	18" PVC/ABS Saw
48-22-0220	18" PVC/ABS Saw Replacement Blade

# TUBING/PIPE CUTTERS & REAMING PEN

## TUBING CUTTER

### INDESTRUCTIBLE FRAME



Replaceable Blades

Model #	Description
48-22-4202	Tubing Cutter
48-22-4203	Tubing Cutter Replacement Blade

## RATCHETING PIPE CUTTERS

### STRAIGHT, EASY CUTS



Comfortable Handle Design

Model #	Description
48-22-4210	1-5/8" Ratcheting Pipe Cutter
48-22-4211	1-5/8" Ratcheting Pipe Cutter Replacement Blade

Model #	Description
48-22-4215	2-3/8" Ratcheting Pipe Cutter
48-22-4216	2-3/8" Ratcheting Pipe Cutter Replacement Blade

## REAMING PEN

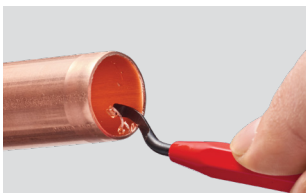

Copper

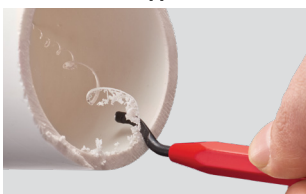

PVC



Model #	Description
48-22-4255	Reaming Pen

## MINI COPPER TUBING CUTTERS

**5X LONGER LIFE**

**REINFORCED ADJUSTMENT MECHANISM**



Chrome Rollers Rust Protection

Model #	Description	Cut Capacity	Extra Blade
48-22-4250	1/2" Mini Copper Tubing Cutter	1/8" – 5/8"	—
48-22-4258	3/4" Mini Copper Tubing Cutter	1/8" – 7/8"	—
48-22-4251	1" Mini Copper Tubing Cutter	1/8" – 1-1/8"	Yes
48-22-4256	2 Pc Replacement Cutter Wheels		—

## CLOSE QUARTERS COPPER TUBING CUTTERS

**MOST COMPACT.  
LONGEST LIFE.**

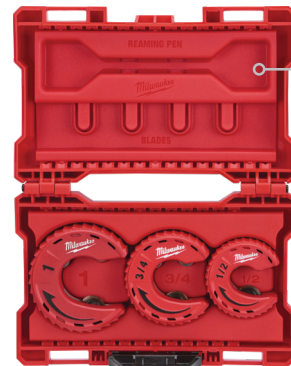

Additional Storage Blades and reaming pen



Chrome Rollers Rust Protection

Model #	Description
48-22-4260	1/2" Close Quarters Copper Tubing Cutter
48-22-4261	3/4" Close Quarters Copper Tubing Cutter
48-22-4262	1" Close Quarters Copper Tubing Cutter
48-22-4263	3 Pc Close Quarters Copper Tubing Cutter Set
48-22-4266	Replacement Copper Tubing Cutter Wheels



## QUICK-ADJUST TUBING CUTTERS

**STRAIGHTER,  
CLEANER CUTS**

**4 CHROME ROLLERS**

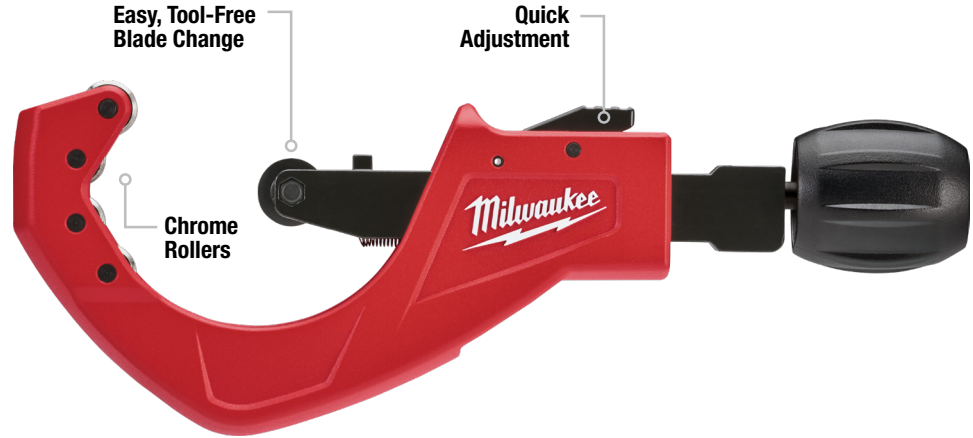

Adapt to Cut 3" PEX



Chrome Rollers Rust Protection

Model #	Description	Cut Capacity
48-22-4253	2-1/2" Quick-Adjust Copper Tubing Cutter	1/2" - 2-5/8"
48-22-4254	3-1/2" Quick-Adjust Copper Tubing Cutter	1/2" - 3-1/2"
48-22-4256	2 Pc Replacement Cutter Wheels	—
48-22-4206	Replacement PEX Cutter Wheel	—

## CONSTANT SWING COPPER TUBING CUTTERS

**STRAIGHTER,  
CLEANER CUTS**

**4 CHROME ROLLERS**



Built-In Reamer on 48-22-4252



Chrome Rollers Rust Protection

Model #	Description	Cut Capacity
48-22-4259	1" Constant Swing Copper Tubing Cutter	1/8" - 1-1/8"
48-22-4252	1-1/2" Constant Swing Copper Tubing Cutter	1/8" - 1-5/8"
48-22-4256	2 Pc Replacement Cutter Wheels	—
48-22-4257	3 Pc Replacement Reaming Blade	—

## PUNCHDOWN TOOL

**BEST ACCESS  
& VISIBILITY**



Integrated LED Light

High / Low Impacting Function

Also Available:



Extended Reach Punchdown Blade  
48-22-2166



Extended Reach Punchdown Blade

Model #	Description	Blades Included
48-22-2165	Punchdown Tool with Extended Blade	66/110 Combination and Extended Reach 110
48-22-2166	Extended Punchdown Blade	Extended Reach 110
48-22-2167	Punchdown Blade	66/110 Combination

## MINI FLUSH CUTTER

**CONSISTENT,  
PRECISE CUTS**



Light Weight



Spring Assisted

Model #	Description
48-22-6105	Mini Flush Cutter

## RATCHETING MODULAR CRIMPER

**CONSISTENT,  
ACCURATE CRIMPS**

Easy Access Jack Removal

In-Line Head Design

Ratcheting Mechanism



Parallel Crimping Design

Model #	Description
48-22-3075	Ratcheting Modular Crimper

MULTI-PICK TOOL

4in1



Model #	Description
48-22-2145	Multi-Pick Tool

ELECTRICIAN SNIPS

BLADES WON'T LOOSEN. BOLT LOCK



Wire Gullet Prevents Walking

Model #	Description
48-22-4045	Electrician Snips

UTP STRIPPER

COMFORTABLE, ONE HAND OPERATION



Optimized Finger Loop

Model #	Description
48-22-3065	UTP Stripper

## CONDUIT BENDER

**HIGH CONTRAST MARKINGS**  
**BEST VISIBILITY**

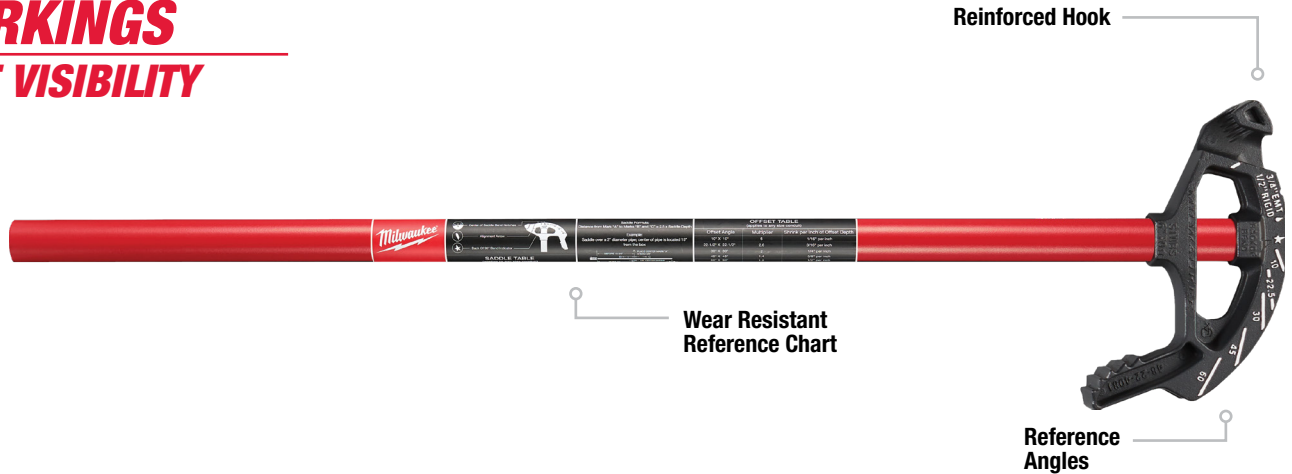

**Reinforced Multi-Position Foot Pedal**

Model #	Description
48-22-4080	1/2" Iron Conduit Bender
48-22-4081	3/4" Iron Conduit Bender
48-22-4082	1" Iron Conduit Bender
48-22-4070	1/2" Aluminum Conduit Bender
48-22-4071	3/4" Aluminum Conduit Bender

## FISH STICKS

**MOST DURABLE CONNECTIONS.**  
**BRIGHTEST GLOW.**



**Reinforced Threaded Connection Points**



MET Part #	Description	Kit Includes
48-22-4149	5ft Low Flex Fish Stick	(1) 5' Low Flex Fish Stick, and Bullet Nose
48-22-4150	15ft Low Flex Fish Stick Kit	(3) 5' Low Flex Fish Sticks, Storage Tube, Bullet Nose and Hook
48-22-4151	5ft Mid Flex Fish Stick	(1) 5' Mid Flex Fish Stick, and Bullet Nose
48-22-4152	15ft Mid Flex Fish Stick Kit	(3) 5' Mid Flex Fish Sticks, Storage Tube, Bullet Nose and Hook
48-22-4153	5ft High Flex Fish Stick	(1) 5' High Flex Fish Stick, and Bullet Nose
48-22-4154	15ft High Flex Fish Stick Kit	(3) 5' High Flex Fish Sticks, Storage Tube, Bullet Nose and Hook

MET Part #	Description	Kit Includes
48-22-4160	25ft Fish Stick Combo Kit	(4) 5' Low Flex, (1) 5' Mid Flex Fish Sticks, (1) Storage Tube, Bullet Nose and Hook
48-22-4155	30ft Fish Stick Combo Kit	(4) 5' Low Flex, (1) 5' Mid Flex, (1) 5' High Flex Fish Sticks, (1) Storage Case, Bullet Nose, Hook, and Whisk
48-22-4156	60ft Fish Stick Combo Kit	(7) 5' Low Flex, (3) 5' Mid Flex, (2) 5' High Flex Fish Sticks, (1) Storage Case, Bullet Nose, Hook, Whisk, Magnet & Chain and Lighted Tip
48-22-4157	3 PC. Fish Stick Accessory Kit	(1) Whisk, Bullet Nose, and Hook
48-22-4158	Fish Stick Lighted Tip Accessory	(1) Lighted Tip Accessory
48-22-4159	Fish Stick Magnetic Tip and Chain Accessory	(1) Magnetic Tip and (1) Chain Accessory



## POLYESTER FISH TAPES

**EASIEST FISHING.  
MORE DURABLE TAPE.**

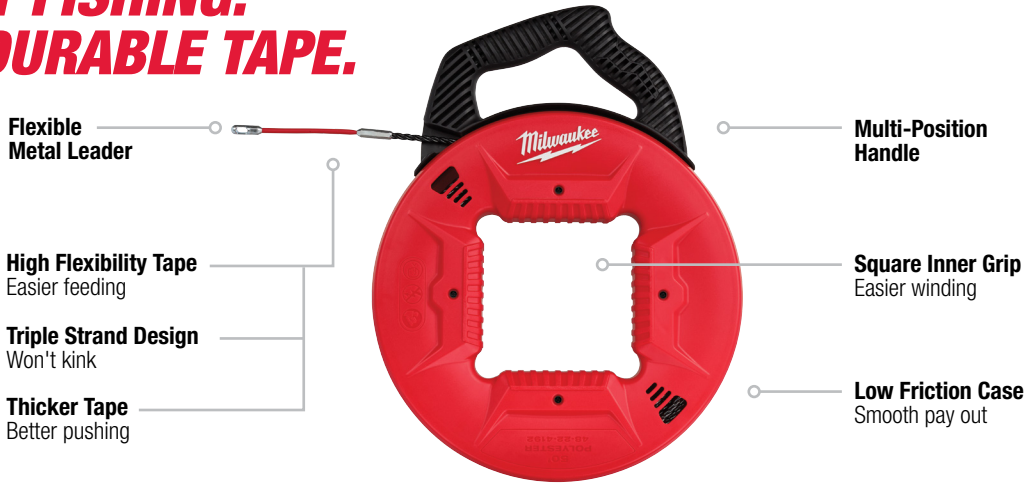

Also Available:



**50ft Polyester Fish Tape with Nonconductive Tip**  
48-22-4162



High Flexibility Tape

Model #	Description
48-22-4192	50ft Polyester Fish Tape with Flexible Metal Leader
48-22-4195	100ft Polyester Fish Tape with Flexible Metal Leader
48-22-4197	200ft Polyester Fish Tape with Flexible Metal Leader
48-22-4162	50ft Polyester Fish Tape with Nonconductive Tip
48-22-4165	100ft Polyester Fish Tape with Nonconductive Tip
48-22-4167	200ft Polyester Fish Tape with Nonconductive Tip

## STEEL FISH TAPES

**SMOOTH PAYOUT.  
EASIER FISHING.**



Laser Etched Markings

Model #	Description
48-22-4171	25ft 1/8" Steel Fish Tape
48-22-4172	50ft 1/8" Steel Fish Tape
48-22-4173	60ft 1/8" Steel Fish Tape
48-22-4176	120ft 1/8" Steel Fish Tape
48-22-4178	240ft 1/8" Steel Fish Tape
48-22-4181	25ft 1/4" Steel Fish Tape with Low Profile Tip
48-22-4185	100ft 1/4" Steel Fish Tape



PACKOUT™ MODULAR STORAGE

# PACKOUT™

**MOST** VERSATILE  
DURABLE  
MODULAR STORAGE SYSTEM

TM



**FULLY  
CUSTOMIZE  
YOUR STORAGE™**



**IMPACT  
RESISTANT™**



**IP65  
RATED  
PROTECTION™**



**BUILD  
YOUR SYSTEM**



# PACKOUT™ MODULAR STORAGE

## ROLLING TOOL BOX



**250 LBS CAPACITY™**



**IMPACT RESISTANT BODY™**



**9" ALL-TERRAIN WHEELS™**

Modular Connectivity with All PACKOUT™ Components

Metal Reinforced Locking Point

IP65 Rated Protection



Industrial-Grade Extension Handle

Interior Organization Tray

Metal Reinforced Corners



9" All-Terrain Wheels

Model #	Description	Weight Capacity
48-22-8426	PACKOUT™ Rolling Tool Box	250 lbs

## TOOL BOXES



**IMPACT RESISTANT BODY™**



**IP65 RATED PROTECTION™**



**METAL-REINFORCED CORNERS™**

Also Available:



PACKOUT™ Tool Box  
48-22-8424

Metal Reinforced Locking Point

IP65 Rated Protection



Modular Connectivity with All PACKOUT™ Components

Metal Reinforced Corners



Interior Organizer Trays

Model #	Description	Weight Capacity
48-22-8424	PACKOUT™ Tool Box	75 lbs
48-22-8425	PACKOUT™ Large Tool Box	100 lbs

## TOOL CASE WITH CUSTOMIZABLE INSERT



**IMPACT RESISTANT BODY™**



**IP65 RATED PROTECTION™**



**CUSTOMIZE YOUR INSERT™**

Also Available:



PACKOUT™ Customizable Foam Insert  
48-22-8451

75lbs Weight Capacity

Impact Resistant Polymer Construction

Reinforced Locking Point



IP65 Rated Protection

Modular Connectivity with All PACKOUT™ Components



Customizable Foam Insert

Model #	Description	Weight Capacity
48-22-8450	PACKOUT™ Tool Case with Customizable Insert	75 lbs
48-22-8451	PACKOUT™ Customizable Foam Insert	—

## COMPACT TOOL BOX



**IMPACT  
RESISTANT  
BODY™**



**IP65  
RATED  
PROTECTION™**



**QUICK-  
ADJUST  
DIVIDERS™**

75 lbs Weight  
Capacity

Quick-Adjust  
Dividers

IP65 Rated  
Protection

Interior  
Storage Tray

Impact Resistant  
Body



Modular Connectivity  
with All PACKOUT™ Components



Interior Storage Tray

Model #	Description	Weight Capacity
48-22-8422	PACKOUT™ Compact Tool Box	75 lbs

## 16QT COOLER



**HOLDS  
ICE FOR  
30  
HRS™**



**IMPACT  
RESISTANT  
BODY™**



**IP65  
RATED  
PROTECTION™**

16 qt Capacity

Bottle Opener

IP65 Rated  
Protection

Interior  
Storage Tray

Impact Resistant  
Body



Modular Connectivity  
with All PACKOUT™ Components



Integrated Bottle Opener

Model #	Description	Weight Capacity
48-22-8460	PACKOUT™ 16qt Compact Cooler	50 lbs



# PACKOUT™ MODULAR STORAGE

## CRATE



**STACK OR HANG™**



**IMPACT RESISTANT BODY™**



**50 LBS CAPACITY™**

50 lbs Weight Capacity

### Stack or Hang

- Rear hanging points for vertical use
- Top attachment points for stacking



Stack or Hang



Modular Connectivity with All PACKOUT™ Components

Impact Resistant Polymer Construction

Model #	Description
48-22-8440	PACKOUT™ Crate

## ORGANIZERS



**IMPACT RESISTANT BODY™**



**IP65 RATED PROTECTION™**



**NO-TRAVEL BIN SEALS™**

Also Available:



PACKOUT™ Compact Organizer  
48-22-8435

No-Travel Bin Seals

Removable & Mountable Bins

IP65 Rated Protection



Impact Resistant Polymer Base

Modular Connectivity with All PACKOUT™ Components



Removable & Mountable Bins

Model #	Description
48-22-8430	PACKOUT™ Organizer
48-22-8435	PACKOUT™ Compact Organizer

## LOW-PROFILE ORGANIZERS



**IMPACT RESISTANT BODY™**



**IP65 RATED PROTECTION™**



**NO-TRAVEL BIN SEALS™**

Also Available:



PACKOUT™ Low-Profile Organizer  
48-22-8431

No-Travel Bin Seals

6 Removable Bin Dividers

IP65 Rated Protection

5 Removable Bins



Impact Resistant Polymer Base

Low-Profile Design

Modular Connectivity with All PACKOUT™ Components



Removable Bins

Model #	Description
48-22-8431	PACKOUT™ Low-Profile Organizer
48-22-8436	PACKOUT™ Low-Profile Compact Organizer

## TOTES



**TEAR-RESISTANT MATERIAL™**



**IMPACT RESISTANT BASE™**



**ALL-METAL HARDWARE™**

Padded Removable Shoulder Strap

Tear-Resistant 1680D Ballistic Material

Modular Connectivity with All PACKOUT™ Components



Durable Overmold Handle

All-Metal Hardware

Impact Resistant Polymer Base

Also Available:



PACKOUT™ 10" Tote  
48-22-8310



PACKOUT™ 15" Tote  
48-22-8315



Optimized Storage Capacity

Model #	Description	Tool Pockets
48-22-8310	PACKOUT™ 10" Tote	28
48-22-8315	PACKOUT™ 15" Tote	31
48-22-8320	PACKOUT™ 20" Tote	32

## TOOL BAGS



**TEAR-RESISTANT MATERIAL™**



**IMPACT RESISTANT BASE™**



**ALL-METAL HARDWARE™**

Spacious Storage Compartment

Tear-Resistant 1680D Ballistic Material

Modular Connectivity with All PACKOUT™ Components



Versatile Carry  
Cushioned shoulder strap, top handles, side handles

All-Metal Hardware

Impact Resistant Polymer Base

Also Available:



PACKOUT™ 15" Tool Bag  
48-22-8321



Spacious Storage Compartment

Model #	Description
48-22-8321	PACKOUT™ 15" Tool Bag
48-22-8322	PACKOUT™ 20" Tool Bag

## COOLER



**HOLDS ICE FOR 24 HRS™**



**ALL-METAL HARDWARE™**



**IMPACT RESISTANT BASE™**

Tape Measure Clip with Bottle Opener

Tear-Resistant Ballistic Material

Impact Resistant Polymer Base



Food-Grade Leak Proof Liner

All-Metal Hardware

No Sweat Exterior

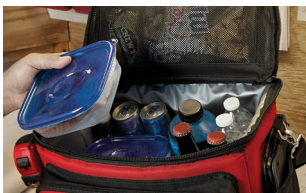

Holds Ice for 24 Hours

Model #	Description
48-22-8302	PACKOUT™ Cooler

# PACKOUT™ MODULAR STORAGE

## BACKPACK



**TEAR-RESISTANT MATERIAL™**



**IMPACT RESISTANT BASE™**



**OPTIMIZED STORAGE CAPACITY™**

Tear-Resistant 1680D Ballistic Material

Hardshell Protected Electronic & Equipment Pocket

Impact Resistant Polymer Base

Load-Bearing Harness  
 ■ Evenly distributes weight  
 ■ Padded and breathable  
 ■ Sternum strap

Tape Measure Clip

Modular Connectivity with All PACKOUT™ Components



Optimized Storage Capacity

Model #	Description	Tool Pockets
48-22-8301	PACKOUT™ Backpack	48

## TECH BAG



**TEAR-RESISTANT MATERIAL™**



**IMPACT RESISTANT BASE™**



**OPTIMIZED STORAGE CAPACITY™**

Padded Shoulder Strap

Tear-Resistant 1680D Ballistic Material

Protected Interior Laptop Pocket

Impact Resistant Polymer Base

All-Metal Hardware

Hardshell Protected Instrument Pocket

Fold Down Front Pocket

Modular Connectivity with All PACKOUT™ Components



Optimized Storage Capacity

Model #	Description	Tool Pockets
48-22-8300	PACKOUT™ Tech Bag	58



## MOUNTING PLATE



**50 LBS**  
WALL MOUNTED  
CAPACITY™



**METAL-REINFORCED**  
MOUNTING  
POINTS™

100 lbs Floor Mounted  
Weight Capacity

50 lbs Wall Mounted  
Weight Capacity

Modular Connectivity with  
All PACKOUT™ Components

Metal Reinforced  
Tie-Down Points

Impact Resistant  
Polymer Construction

Metal-Reinforced  
Mounting Holes



Wall & Floor Mounting

Model #	Description
48-22-8485	PACKOUT™ Mounting Plate

## DOLLY



**250 LBS**  
CAPACITY™



**QUICKSTOP**  
LOADING LEVER™



**SMOOTH**  
ROLL  
WHEELS™

250 lbs Weight  
Capacity

Modular Connectivity with  
All PACKOUT™ Components

Impact Resistant  
Polymer Construction

Locking Casters

Smooth Roll  
Wheels



QUICKSTOP™ Loading Lever

Model #	Description
48-22-8410	PACKOUT™ Dolly



## JOBSITE TECH BAG

UP TO **5X** MORE DURABLE

All-Metal Hardware

Integrated Rain Fly

Puncture Resistant Pocket

Impact-Resistant Base



Model #	Description
48-22-8210	Jobsite Tech Bag

## HARDTOP™ ROLLING BAGS

**MOST DURABLE. ULTIMATE VERSATILITY.**

Industrial Grade Extension Handle

HARDTOP™ Construction For stacking

Metal-Reinforced Skid Plates

6" All-Terrain Wheels

Padded Tech Pocket

All-Metal Rims & Through Axle



Model #	Description
48-22-8221	18" Rolling Bag
48-22-8220	24" HARDTOP™ Rolling Bag

## JOBSITE COOLER

HOLDS ICE UP TO **24HRS**



2X the Insulation

Model #	Description
48-22-8250	Jobsite Cooler

## LOW-PROFILE BACKPACK

**DURABLE,  
LOW-PROFILE DESIGN**



1680D Ballistic Nylon

Model #	Description	Pockets
48-22-8202	Low-Profile Backpack	22

## JOBSITE BACKPACK

UP TO **5X MORE DURABLE**



Impact-Resistant Base

Model #	Description	Pockets
48-22-8200	Jobsite Backpack	35

## ULTIMATE JOBSITE BACKPACK

**ULTIMATE DURABILITY,  
PROTECTION, & STORAGE**



Impact-Resistant Base

Model #	Description	Pockets
48-22-8201	Ultimate Jobsite Backpack	48

## PARACHUTE ORGANIZER BAG

**FASTEST ACCESS,  
BEST CONSTRUCTION**



Stand-Up & Stay-Open Design

Model #	Description
48-22-8170	Parachute Organizer Bag

## BUCKET ORGANIZER WRAP

**MOST VERSATILE  
BUCKET ORGANIZER**



Exterior Zipper Pockets

Model #	Description
48-22-8175	Bucket Organizer Wrap



## ZIPPER POUCHES

UP TO **2X MORE DURABLE**



3 Pc Multi-Size Zipper Pouches  
48-22-8183



Water Resistant Stand-Up Base

Model #	Description
48-22-8180	Zipper Pouch
48-22-8193	3 Pc Zipper Pouches
48-22-8183	3 Pc Multi-Size Zipper Pouches

## JOBSITE ORGANIZER

**MOST VERSATILE  
JOBSITE ORGANIZER**



No-Travel Bin Seals

Model #	Description
48-22-8030	20" Jobsite Organizer

## WORK BELTS & POUCHES

UP TO **5X** LONGER LIFE

**Contractor's Work Belt with Suspension Rig**  
48-22-8120



**Electrician's Work Belt**  
48-22-8110

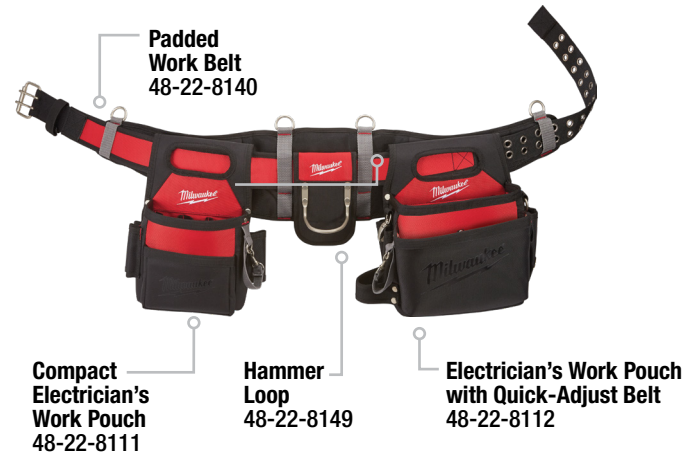

Model #	Description
48-22-8100	Electrician's Work Belt with Quick-Adjust Belt
48-22-8110	Electrician's Work Belt
48-22-8111	Compact Electrician's Work Pouch
48-22-8120	Contractor's Work Belt with Suspension Rig
48-22-8121	Carpenter's Work Pouch
48-22-8122	3-Tier Material Work Pouch

Model #	Description
48-22-8140	Padded Work Belt
48-22-8145	Padded Rig
48-22-8146	XL Padded Rig
48-22-8149	Hammer Loop
48-22-8112	Electrician's Work Pouch with Quick-Adjust Belt

## COMPACT UTILITY POUCH

UP TO **5X** LONGER LIFE



**Quick-Attach Belt Loop**

Model #	Description
48-22-8118	Compact Utility Pouch

## UTILITY POUCH



**Quick-Attach Belt Loop**

Model #	Description
48-22-8119	Utility Pouch

# POWER UTILITY STORAGE

## LINEMAN'S AERIAL TOOL APRON

**EASY ORGANIZATION.  
LASTING DURABILITY.**



Dedicated Flood Light

Model #	Description
48-22-8290	Lineman's Aerial Tool Apron

## UNDERGROUND OVAL BAG

**UP TO 5X MORE DURABLE**



Puncture Resistant Pockets

Model #	Description
48-22-8275	Underground Oval Bag

## AERIAL OVAL BAG

UP TO **5X** MORE DURABLE

**Puncture Resistant Knife Pockets**

**1680D Ballistic Material**

**Weep Holes**  
Let water out



**2 Durable Eyelets**

**2 D-Rings**  
More storage

**14 Pockets**

**Impact-Resistant Molded Base**



**Puncture Resistant Pockets**

Model #	Description
48-22-8276	Aerial Oval Bag

## CANVAS UTILITY BUCKET w/ POCKETS

**EASIEST ATTACHMENT.  
LASTING DURABILITY.**

**2 Internal Pockets**

**Reinforced Ring**  
Keeps bag open

**Durable No. 6 Canvas**

**Weep Holes**  
Let water out



**Large, Swiveling Metal Carabiner**

**2 D-Rings**  
Additional storage

**Impact-Resistant Molded Base**



**Double Layered Canvas Construction**

Model #	Description
48-22-8270	Canvas Utility Bucket w/ Pockets



## DEMOLITION GLOVES WITH SMARTWIPE™

UP TO **5X LONGER LIFE**



Touch Screen Compatible Knuckle

ARMORTEX® Reinforced Thumb, Fingers and Padded Palm



TPR Knuckle Protection

Breathable Lining & Mesh Backing

Terry Cloth Sweat Wipe

Model #	Description
48-22-8735	Demolition Gloves S
48-22-8731	Demolition Gloves M
48-22-8732	Demolition Gloves L

Model #	Description
48-22-8733	Demolition Gloves XL
48-22-8734	Demolition Gloves XXL

## PERFORMANCE GLOVES WITH SMARTWIPE™

**ULTIMATE DURABILITY. ALL DAY COMFORT.**

Also Available:



Performance Fingerless Gloves

High Dexterity Finger Tips

Reinforced Thumb Seam



Breathable Lining

Terry Cloth Sweat Wipe



Touch Screen Compatible Fingertips, Palm & Knuckle

Model #	Description
48-22-8725	Performance Gloves S
48-22-8721	Performance Gloves M
48-22-8722	Performance Gloves L
48-22-8723	Performance Gloves XL
48-22-8724	Performance Gloves XXL

Model #	Description
48-22-8745	Performance Fingerless Gloves S
48-22-8741	Performance Fingerless Gloves M
48-22-8742	Performance Fingerless Gloves L
48-22-8743	Performance Fingerless Gloves XL
48-22-8744	Performance Fingerless Gloves XXL

## FREE-FLEX GLOVES WITH SMARTWIPE™

**ULTIMATE DURABILITY. ALL DAY COMFORT.**



Touch Screen Compatible Fingertips, Palm & Knuckle

High Dexterity Finger Tips

Reinforced Thumb Seam

Free-Flex Elastic Cuff



Terry Cloth Sweat Wipe

Model #	Description
48-22-8715	Free-Flex Gloves S
48-22-8711	Free-Flex Gloves M
48-22-8712	Free-Flex Gloves L

Model #	Description
48-22-8713	Free-Flex Gloves XL
48-22-8714	Free-Flex Gloves XXL

## GOATSKIN LEATHER GLOVES

**COMFORTABLE LEATHER.  
REINFORCED PALM.**



SMARTSWIPE™ Knuckle

**Gunn Cut Construction**  
Added mobility

**Reinforced Palm**  
Lasts Longer

**Keystone Thumb**  
Comfortable Fit

**SMARTSWIPE™**  
Touch Screen  
Compatible  
Fingertips & Palms

**Soft Top Grain**  
Goatskin Leather



Size	1 Pair	12 Pair (Contractor Pack)
S	48-73-0010	48-73-0010B
M	48-73-0011	48-73-0011B
L	48-73-0012	48-73-0012B

Size	1 Pair	12 Pair (Contractor Pack)
XL	48-73-0013	48-73-0013B
XXL	48-73-0014	48-73-0014B

## IMPACT DEMOLITION GLOVES

**IMPACT PROTECTION.  
REINFORCED DURABILITY.**

ANSI / ISEA 138



Padded Palm

**Padded Palm**  
Vibration dampening

**Reinforced with**  
**ARMORTEX®**

**Impact Rated**  
**Enhanced TPR**

**Secure Hook**  
**& Loop**  
**Closure**



Size	1 Pair	12 Pair (Contractor Pack)
S	48-22-8750	48-22-8750B
M	48-22-8751	48-22-8751B
L	48-22-8752	48-22-8752B

Size	1 Pair	12 Pair (Contractor Pack)
XL	48-22-8753	48-22-8753B
XXL	48-22-8754	48-22-8754B

## WINTER DEMOLITION GLOVES

**ALL DAY WARMTH.  
REINFORCED DURABILITY.**



Waterproof & Windproof Layer

**40g**  
**Insulation**  
Added warmth

**Terry Cloth**  
**Sweat Wipe**

**Durable Reinforced**  
**Palm & Fingertips**

**SMARTSWIPE™**  
Touch Screen  
Knuckle

**Waterproof &**  
**Windproof**  
**Layer**

**Secure Hook**  
**& Loop**  
**Closure**



Size	1 Pair	12 Pair (Contractor Pack)
S	48-73-0040	48-73-0040B
M	48-73-0041	48-73-0041B
L	48-73-0042	48-73-0042B

Size	1 Pair	12 Pair (Contractor Pack)
XL	48-73-0043	48-73-0043B
XXL	48-73-0044	48-73-0044B

## WINTER PERFORMANCE GLOVES

### ALL DAY WARMTH.



Durable Reinforced Palm and Fingertips



Size	1 Pair	12 Pair (Contractor Pack)
S	48-73-0030	48-73-0030B
M	48-73-0031	48-73-0031B
L	48-73-0032	48-73-0032B

Size	1 Pair	12 Pair (Contractor Pack)
XL	48-73-0033	48-73-0033B
XXL	48-73-0034	48-73-0034B

## CUT LEVEL 1 INSULATED WINTER GLOVES

### ULTIMATE WARMTH. ALL DAY COMFORT.

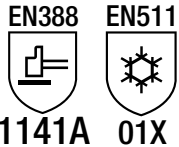

Size	1 Pair	12 Pair (Contractor Pack)
S	48-22-8910	48-22-8910B
M	48-22-8911	48-22-8911B
L	48-22-8912	48-22-8912B



Size	1 Pair	12 Pair (Contractor Pack)
XL	48-22-8913	48-22-8913B
XXL	48-22-8914	48-22-8914B

## CUT LEVEL 3 INSULATED WINTER GLOVES

### ULTIMATE WARMTH. ALL DAY COMFORT.

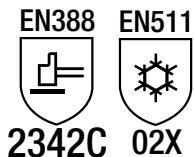

Size	1 Pair	12 Pair (Contractor Pack)
S	48-22-8920	48-22-8920B
M	48-22-8921	48-22-8921B
L	48-22-8922	48-22-8922B



Size	1 Pair	12 Pair (Contractor Pack)
XL	48-22-8923	48-22-8923B
XXL	48-22-8924	48-22-8924B



## CUT LEVEL 1 DIPPED GLOVES WITH SMARTSWIPE™

**ULTIMATE DURABILITY.  
ALL DAY COMFORT.**

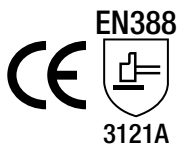

Size	1 Pair	12 Pair (Contractor Pack)
S	48-22-8900	48-22-8900B
M	48-22-8901	48-22-8901B
L	48-22-8902	48-22-8902B

**SMARTSWIPE™**  
Touch Screen  
Compatible  
Index Finger

**High Dexterity**  
Fingertips

**Nitrile Coated**  
Better grip



**Nylon/Lycra Liner**  
All day comfort

**Breathable**  
Backing

**Color-Coded Bands**  
Easy cut rating  
identification

Size	1 Pair	12 Pair (Contractor Pack)
XL	48-22-8903	48-22-8903B
XXL	48-22-8904	48-22-8904B

## CUT LEVEL 3 DIPPED GLOVES WITH SMARTSWIPE™

**ULTIMATE DURABILITY.  
ALL DAY COMFORT.**

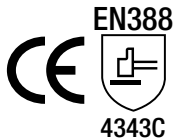

Size	1 Pair	12 Pair (Contractor Pack)
S	48-22-8930	48-22-8930B
M	48-22-8931	48-22-8931B
L	48-22-8932	48-22-8932B

**SMARTSWIPE™**  
Touch Screen  
Compatible  
Fingertips & Palms

**Nitrile Web Grip**  
Comfort



**Best-In-Class**  
Puncture  
Resistance

**Breathable**  
Backing

**Color-Coded Bands**  
Easy cut rating  
identification

Size	1 Pair	12 Pair (Contractor Pack)
XL	48-22-8933	48-22-8933B
XXL	48-22-8934	48-22-8934B

## CUT LEVEL 5 DIPPED GLOVES WITH SMARTSWIPE™

**ULTIMATE DURABILITY.  
ALL DAY COMFORT.**

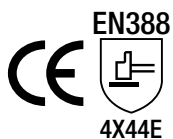

Size	1 Pair	12 Pair (Contractor Pack)
S	48-22-8950	48-22-8950B
M	48-22-8951	48-22-8951B
L	48-22-8952	48-22-8952B

**SMARTSWIPE™**  
Touch Screen  
Compatible  
Fingertips & Palms

**Double Dipped**  
Nitrile Coating  
Best-in-class  
durability



**Best-In-Class**  
Puncture  
Resistance

**Breathable**  
Backing

**Color-Coded Bands**  
Easy cut rating  
identification

Size	1 Pair	12 Pair (Contractor Pack)
XL	48-22-8953	48-22-8953B
XXL	48-22-8954	48-22-8954



# POLYURETHANE GLOVES

## HIGH VISIBILITY CUT LEVEL 2 POLYURETHANE DIPPED GLOVES

**BETTER FIT.  
BETTER PROTECTION.**

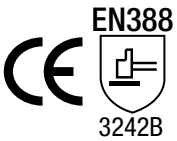

Size	1 Pair	12 Pair (Contractor Pack)
S	48-73-8920	48-73-8920B
M	48-73-8921	48-73-8921B
L	48-73-8922	48-73-8922B

15 Gauge for Better Dexterity

Reinforced Nitrile Coating

High Performance Added protection

Polyurethane Better fit



SMARTSWIPE™ Touch Screen Compatible Fingertips & Palms

Light and Breathable Back

Color-Coded Bands Easy cut rating identification

Size	1 Pair	12 Pair (Contractor Pack)
XL	48-73-8923	48-73-8923B
XXL	48-73-8924	48-73-8924B

## HIGH VISIBILITY CUT LEVEL 3 POLYURETHANE DIPPED GLOVES

**BETTER FIT.  
BETTER PROTECTION.**



Size	1 Pair	12 Pair (Contractor Pack)
S	48-73-8930	48-73-8930B
M	48-73-8931	48-73-8931B
L	48-73-8932	48-73-8932B

15 Gauge for Better Dexterity

Reinforced Nitrile Coating

High Performance Added protection

Polyurethane Better fit



SMARTSWIPE™ Touch Screen Compatible Fingertips & Palms

Light and Breathable Back

Color-Coded Bands Easy cut rating identification

Size	1 Pair	12 Pair (Contractor Pack)
XL	48-73-8933	48-73-8933B
XXL	48-73-8934	48-73-8934B

## HIGH VISIBILITY CUT LEVEL 4 POLYURETHANE DIPPED GLOVES

**BETTER FIT.  
BETTER PROTECTION.**

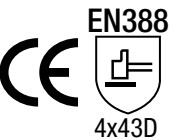

Size	1 Pair	12 Pair (Contractor Pack)
S	48-73-8940	48-73-8940B
M	48-73-8941	48-73-8941B
L	48-73-8942	48-73-8942B

Reinforced Nitrile Coating

High Performance Added protection

Polyurethane Better fit



SMARTSWIPE™ Touch Screen Compatible Fingertips & Palms

Light and Breathable Back

Color-Coded Bands Easy cut rating identification

Size	1 Pair	12 Pair (Contractor Pack)
XL	48-73-8943	48-73-8943B
XXL	48-73-8944	48-73-8944B

## HARD HATS

### ADAPT TO YOUR JOBSITE

- ANSI/ISEA Z89.1
- CSA Z94.1
- TYPE I CLASS C**
- ANSI/ISEA Z89.1
- CSA Z94.1
- TYPE I CLASS E**

**Temperature Reducing Vents**  
On vented hard hats only

**BOLT™ Reversible Headlamp Mount**

- Securely holds MILWAUKEE® and most other professional brand headlamps
- Mounts to front or back

**Quick-Adjust Ratcheting Suspension**

**4-Point Padded Suspension**



**Large Sun-Blocking Brim**

**Moisture Wicking Sweat Band**

**BOLT™ Marker Clip**  
Securely holds a marker or pencil

**6 Accessory Slots**

- 4 BOLT™ Accessory Slots
- 2 Universal Slots

**ALSO AVAILABLE**



**Front Brim Hard Hat**



**Quick-Adjust Ratcheting Suspension**

Large Logo	Small Logo	Description
48-73-1000	48-73-1001	Front Brim Vented Hard Hat – Type I Class C
48-73-1010	48-73-1011	Full Brim Vented Hard Hat – Type I Class C
48-73-1020	48-73-1021	Front Brim Hard Hat – Type I Class E
48-73-1030	48-73-1031	Full Brim Hard Hat – Type I Class E
48-73-1080	—	Hard Hat Sweat Band
48-73-1082	—	Hard Hat Chin Strap
48-73-1085	—	BOLT™ Hard Hat Marker Clip
48-73-1090	—	BOLT™ Hard Hat Headlamp Mount
48-73-1095	—	4-Point Ratchet Suspension Replacement
2111-21	—	USB Rechargeable Hard Hat Headlamp Kit
2103	—	Headlamp

*Headlamp and marker not included.*

## HIGH VISIBILITY PERFORMANCE SAFETY VESTS

### CARRY MORE. REINFORCED POCKETS.

#### 15 Pockets

##### External:

- 2 Mic Tabs
- 1 Clear ID Holder
- 2 Chest Pockets
- 4 Reinforced Pen Pockets
- 2 Reinforced Barrel Pockets
- 1 Tablet Pocket

##### Internal:

- 1 Chest Pocket
- 2 Barrel Pockets

ANSI/ISEA 107-15

**TYPE R CLASS 2**

CSA Z96-15

**CLASS 2**



Internal Size Adjustment

Secure Zippered Closure



Fall Protection Pass Through

Rear Zippered Tablet Pocket

ALSO AVAILABLE



ANSI/CSA Safety Vests

Size	Yellow – ANSI	Orange – ANSI	Yellow – ANSI/CSA	Orange – ANSI/CSA
S/M	48-73-5041	48-73-5051	48-73-5081	48-73-5091
L/XL	48-73-5042	48-73-5052	48-73-5082	48-73-5092
2XL/3XL	48-73-5043	48-73-5053	48-73-5083	48-73-5093
4XL/5XL	48-73-5044	48-73-5054	48-73-5084	48-73-5094

## HIGH VISIBILITY SAFETY VESTS

### CARRY MORE

#### 10 Pockets

##### External:

- 2 Mic Tabs
  - 1 Clear ID Holder
  - 2 Chest Pockets
  - 4 Reinforced Pen Pockets
- ##### Internal:
- 1 Chest Pocket

Secure Zippered Closure



Internal Size Adjustment



Fall Protection Pass Through

ALSO AVAILABLE



ANSI/CSA Safety Vests

Size	Yellow – ANSI	Orange – ANSI	Yellow – ANSI/CSA	Orange – ANSI/CSA
S/M	48-73-5021	48-73-5031	48-73-5061	48-73-5071
L/XL	48-73-5022	48-73-5032	48-73-5062	48-73-5072
2XL/3XL	48-73-5023	48-73-5033	48-73-5063	48-73-5073
4XL/5XL	48-73-5024	48-73-5034	48-73-5064	48-73-5074

MILWAUKEE® enables you to add logos or taglines to your hard hat and safety vest. The order process makes it easy to customize your PPE with long lasting prints.

## HARD HAT CUSTOMIZATION

### Hard Hat Logo Placement

Up to 4 locations



Front



Back



Left Side



Right Side

Hard Hat	Logo Size
Front/Back	2.5" W x 2" H
Sides	2.5" W x 2" H

## PRINT UP TO 4 COLORS

## HARD HAT CUSTOMIZATION

### Safety Vest Logo Placement

Up to 2 locations



Left Pocket



Back



Lower Back

Safety Vest – ANSI	Logo Size
Left Pocket	3" W x 2.5" H
Back	9" W x 9" H
Performance Safety Vest – ANSI	Logo Size
Left Pocket	3" W x 2.5" H
Back	10" W x 6" H
Safety Vest – ANSI/CSA	Logo Size
Left Pocket	3" W x 2.5" H
Lower Back	15" W x 6" H
Performance Safety Vest – ANSI/CSA	Logo Size
Left Pocket	3" W x 2" H
Lower Back	15" W x 6" H

## PRINT UP TO 2 COLORS

## HOW TO SUBMIT ORDER

1. Place order through Sales Representative, Customer Experience, or MILWAUKEE® Connect
2. Once order is placed, an email will be sent with a link to the logo upload process
3. You will then receive an email with a link to review and approve a proof

### LEAD TIME

- Artwork Proof will be sent within 1 business day after finishing the logo upload process
- Order will be fulfilled within 14 – 21 days from proof approval

### ORDER MINIMUMS

- Hard Hats: Minimum order quantity of 36, must add in increments of 18
- Safety Vests: Minimum order quantity of 36, must add in increments of 36

### MORE INFORMATION

- Email [CXCustomSafety@milwaukeetool.com](mailto:CXCustomSafety@milwaukeetool.com) with questions

Once artwork is approved by the customer, the order cannot be canceled. Lead times are based on artwork approval date, not order date. If customer fails to approve artwork, order may be delayed. Orders placed with a mismatch on number of colors, locations, or logos will need to have the artwork updated or the order re-entered. Images may have some distortion on curved surfaces – the printer can accommodate for some, but it may not turn out the same as the flat image.



# SAFETY GLASSES

## PERFORMANCE SAFETY GLASSES WITH GASKET

**ADVANCED PROTECTION.  
ULTIMATE PERFORMANCE.**



Case Included



Lens Color	Packaging Style – Blister Card	Packaging Style – Bag
Polarized	48-73-2045	48-73-2046
Clear	48-73-2040	48-73-2041

## PERFORMANCE SAFETY GLASSES

**HIGH IMPACT  
FOG-FREE LENSES**

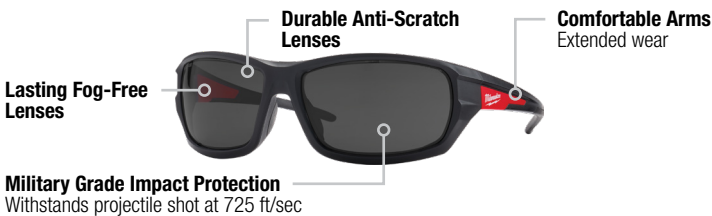

Lens Color	Packaging Style – Blister Card	Packaging Style – Bag
Tinted	48-73-2025	48-73-2026
Clear	48-73-2020	48-73-2021

## SAFETY GLASSES

**ANTI-FOG.  
ANTI-SCRATCH.**



Lens Color	Packaging Style – Blister Card	Packaging Style – 3 Pk Blister Card	Packaging Style – Bag
Tinted	48-73-2005	48-73-2051	48-73-2006
Clear	48-73-2000	48-73-2050	48-73-2001



## N95 VALVED RESPIRATORS

**STAY COOL.  
BETTER FIT.**

ALSO AVAILABLE



N95 Valved Respirator



**NIOSH  
N95**

### N95 VALVED RESPIRATOR WITH GASKET

MET Part #	Description
48-73-4001	N95 Valved Respirator with Gasket
48-73-4002	3 Pk N95 Valved Respirator with Gasket
48-73-4004	10 Pk N95 Valved Respirator with Gasket

### N95 VALVED RESPIRATOR

MET Part #	Description
48-73-4011	N95 Valved Respirator
48-73-4012	3 Pk N95 Valved Respirator
48-73-4014	10 Pk N95 Valved Respirator

## REUSABLE CORDED EAR PLUGS

**ALL DAY COMFORT**



**NRR  
26**

MET Part #	Description
48-73-3151	3 Pk Reusable Corded Ear Plugs

## EAR PLUGS

**ALL DAY COMFORT**



**NRR  
32**

MET Part #	Description
48-73-3001	10 Pair Ear Plugs
48-73-3005	100 Pair Ear Plugs
48-73-3006	100 Pair Ear Plugs (Individually Wrapped)

## LOCKING TOOL LANYARDS

### BEST SHOCK ABSORPTION

ANSI/ISEA

121-18



Integrated Swivel

Color Coded  
Easy weight  
identification

Double-Locking  
Carabiner

Individualized Serial Numbers  
Inventory management

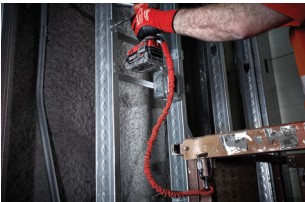

Tether Tools When  
Working at Height

Part #	Weight Rating	Description
48-22-8810	10 lbs	10 lbs Locking Tool Lanyard
48-22-8811	10 lbs	10 lbs 54" Extended Reach Locking Tool Lanyard
48-22-8812	10 lbs	10 lbs 72" Extended Reach Locking Tool Lanyard
48-22-8815	15 lbs	15 lbs Locking Tool Lanyard
48-22-8816	15 lbs	15 lbs 54" Extended Reach Locking Tool Lanyard
48-22-8817	15 lbs	15 lbs 72" Extended Reach Locking Tool Lanyard
48-22-8850	35 lbs	35 lbs Locking Tool Lanyard

## QUICK-CONNECT LOCKING TOOL LANYARD SYSTEM

### BEST SHOCK ABSORPTION

ANSI/ISEA

121-18



Integrated Swivel

Double-Locking  
Carabiner

Color Coded  
Easy weight  
identification

Individualized  
Serial Numbers  
Inventory management



Quick Tool Change Out

Part #	Weight Rating	Description
48-22-8820	10 lbs	10 lbs Quick-Connect Locking Tool Lanyard
48-22-8822	5 lbs	3 Pc 5 lbs Quick-Connect Lanyard Accessory
48-22-8823	10 lbs	3 Pc 10 lbs Quick-Connect Lanyard Accessory

## ANCHOR STRAP

### TETHER MORE TOOLS, MORE PLACES

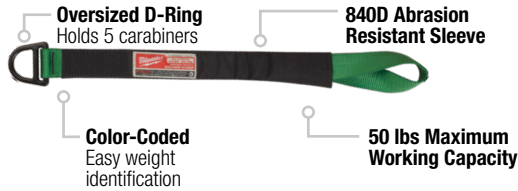

**ANSI/SEA  
121-18**

Model #	Weight Rating	Description
48-22-8855	50 lbs	50 lbs Anchor Strap

## WRIST LANYARDS

### ALL DAY COMFORT



Model #	Weight Rating	Description
48-22-8830	5 lbs	5 Pc Wrist Lanyard
48-22-8835	5 lbs	5 lbs Quick-Connect Wrist Lanyard

## TAPE & D-RING WEB ATTACHMENTS

### EASILY CONNECT



Model #	Weight Rating	Description
48-22-8860		12' Self-Adhering Tape
48-22-8870	2 lbs	5 Pc 2 lbs D-Ring Web Attachment
48-22-8871	5 lbs	5 Pc 5 lbs D-Ring Web Attachment
48-22-8872	35 lbs	D-Ring 35 lbs Web Attachment

## SPLIT RINGS

### EASILY CONNECT

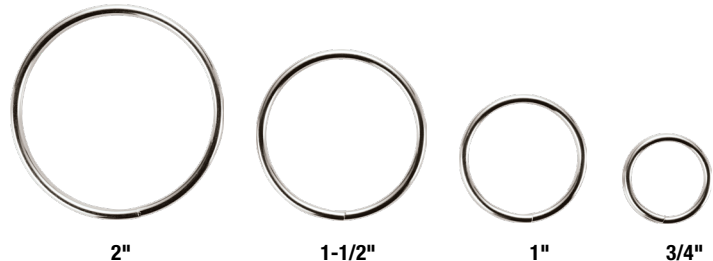

Model #	Weight Rating	Description
48-22-8880	2 lbs	5 Pc 2 lbs 3/4" Split Ring
48-22-8881	2 lbs	5 Pc 2 lbs 1" Split Ring
48-22-8882	2 lbs	5 Pc 2 lbs 1-1/2" Split Ring
48-22-8883	2 lbs	5 Pc 2 lbs 2" Split Ring



2	<b>TAPE MEASURES</b>
4	<b>LONG TAPES &amp; MEASURING WHEELS</b>
5	<b>REDSTICK™ LEVELS</b>
7	<b>REDSTICK™ CONCRETE LEVELS &amp; TORPEDO LEVELS</b>
8	<b>SQUARES &amp; LASER DISTANCE METERS</b>
9	<b>FOLDING RULES &amp; CHALK REELS</b>
10	<b>INKZALL™ JOBSITE MARKERS</b>
11	<b>INKZALL™ PAINT MARKERS, PENS &amp; HIGHLIGHTERS</b>
12	<b>FASTENING PLIERS</b>
13	<b>FASTENING &amp; CUTTING PLIERS</b>
14	<b>CUTTING PLIERS</b>
15	<b>COMBINATION &amp; MULTI-FUNCTION PLIERS</b>
16	<b>APPLICATION SPECIFIC PLIERS</b>
17	<b>TORQUE LOCK™ PLIERS, C-CLAMPS &amp; SPECIALTY</b>
18	<b>RATCHETING BOX WRENCHES &amp; POWER UTILITY WRENCH</b>
19	<b>POWER UTILITY WRENCH &amp; PIPE WRENCHES</b>
20	<b>PIPE WRENCHES</b>
21	<b>PIPE WRENCHES &amp; MULTI BIT DRIVERS</b>
22	<b>ADJUSTABLE &amp; BASIN WRENCHES</b>
23	<b>RATCHET &amp; SOCKET SETS</b>
24	<b>RATCHETING COMBINATION WRENCHES</b>
25	<b>COMBINATION WRENCHES</b>
26	<b>SOCKETS</b>
27	<b>DRIVE RATCHETS, BREAKER BARS &amp; SOCKET ACCESSORIES</b>
28	<b>HOOK AND PICK SET &amp; MULTI-BIT DRIVERS</b>
29	<b>SCREWDRIVERS</b>
30	<b>DEMO DRIVERS &amp; SCREWDRIVERS</b>
31	<b>NUT DRIVERS</b>
32	<b>HAMMERS &amp; FIXED BLADE KNIVES</b>
33	<b>LINEMAN, FIXED BLADE, &amp; POCKET KNIVES</b>
34	<b>FASTBACK™ FOLDING KNIVES</b>
35	<b>FASTBACK™ POCKET &amp; FOLDING KNIVES</b>
36	<b>FASTBACK™ UTILITY KNIVES &amp; UTILITY KNIVES</b>
38	<b>UTILITY, SAFETY, &amp; SNAP OFF KNIVES</b>
39	<b>INSULATION &amp; DUCT KNIVES</b>
40	<b>AVIATION SNIPS</b>
41	<b>TINNERS</b>
42	<b>SCISSORS,&amp; BOLT CUTTERS</b>
43	<b>BOLT CUTTERS &amp; HACKSAWS</b>
44	<b>SAWS</b>
45	<b>TUBING/PIPE CUTTERS &amp; REAMING PEN</b>
47	<b>COPPER TUBING CUTTERS</b>
48	<b>LOW VOLTAGE VDV</b>
50	<b>CONDUIT BENDERS</b>
51	<b>FISH TAPES</b>
52	<b>PACKOUT™ MODULAR STORAGE</b>
59	<b>BAGS</b>
60	<b>COOLERS &amp; BACKPACKS</b>
61	<b>BACKPACKS</b>
62	<b>ORGANIZERS</b>
64	<b>WORK BELTS &amp; UTILITY POUCHES</b>
65	<b>POWER UTILITY STORAGE</b>
67	<b>WORK GLOVES</b>
69	<b>NITRILE GLOVES</b>
71	<b>POLYURETHANE GLOVES</b>
72	<b>HARD HATS</b>
73	<b>SAFETY VESTS</b>
74	<b>PRODUCT CUSTOMIZATION</b>
75	<b>SAFETY GLASSES</b>
76	<b>RESPIRATORS</b>
77	<b>LANYARDS</b>
78	<b>LANYARD ACCESSORIES</b>



**MILWAUKEE TOOL**  
**13135 West Lisbon Road**  
**Brookfield, WI 53005**

**[milwaukeetool.com](http://milwaukeetool.com)**

